

TCFX-77 Sony

Cassette Model
AEF Model
UK Model

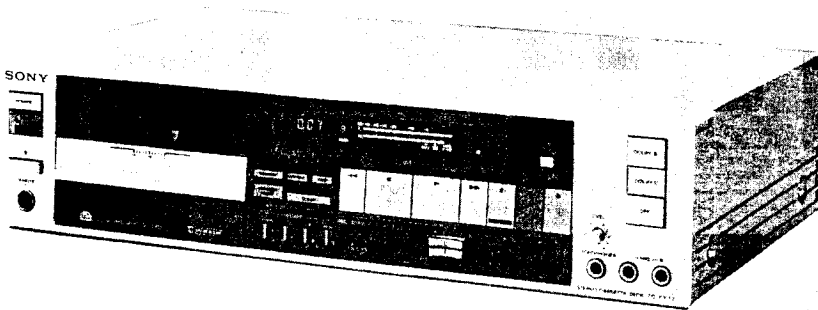

For Service Manuals Contact
MAURITRON TECHNICAL SERVICES
8 Cherry Tree Rd, Chinnor
Oxon OX9 4QY
Tel: 01844-351694 Fax: 01844-352554
Email: enquires@mauritron.co.uk

STEREO CASSETTE DECK

SPECIFICATIONS

Recording system 4-track 2-channel stereo
Fast-forward and rewind time
Approx. 90 sec. (with C-60 cassette)
Bias frequency 105 kHz
Signal-to-noise ratio (NAB, at peak level)

Cassette	Dolby NR switch	OFF	B-TYPE ON	C-TYPE ON
TYPE IV (Sony METALLIC)		59 dB	66 dB	72 dB
TYPE III (Sony FeCr)		60 dB	67 dB	73 dB
TYPE II (Sony CD- α)		57 dB	64 dB	70 dB
TYPE I (Sony BHF)		54 dB	61 dB	67 dB

Total harmonic distortion
1.0% (with Sony METALLIC and FeCr
cassettes)

— Continued on page 2 —

Tape Transport Mechanism TCM-110V13



SERVICE MANUAL

Frequency response DOLBY NR OFF

- With TYPE IV cassette (Sony METALLIC)
 - 20 - 19,000 Hz
 - 30 - 17,000 Hz (± 3 dB)
 - 30 - 13,000 Hz (± 3 dB, 0 VU recording)
 - 30 - 17,000 Hz (DIN)
- With TYPE III cassette (Sony FeCr)
 - 20 - 19,000 Hz
 - 30 - 17,000 Hz (± 3 dB)
 - 30 - 17,000 Hz (DIN)
- With TYPE II cassette (Sony CD- α)
 - 20 - 18,000 Hz
 - 30 - 16,000 Hz (± 3 dB)
 - 30 - 16,000 Hz (DIN)
- With TYPE I cassette (Sony BHF)
 - 20 - 17,000 Hz
 - 30 - 14,000 Hz (DIN)

Wow and flutter

0.04 % WRMS (NAB)
 ± 0.14 % (DIN)

Inputs

Microphone inputs (phone jacks)
 Sensitivity 0.25 mV (-70 dB)
 For a low-impedance microphone
 Line inputs (phono jacks)
 Sensitivity 77.5 mV (-20 dB)
 Input impedance 50 k ohms

Outputs

Line outputs (phono jacks)

Output level 0.435 V (-5 dB) at load
 impedance 50 k ohms
 Load impedance over 10 k ohms

Headphone output

Output level variable -20 to -50 dB at a
 load impedance of 8 ohms

General

Power requirements 120 V ac, 60 Hz. US Canadian Model
 220 V ac, 50/60 Hz. AEP Model
 (240 V ac adjustable by authorized
 Sony personnel)
 240 V ac, 50/60 Hz. UK Model
 (220 V ac adjustable by authorized
 Sony personnel)

Power consumption

26 watts

Dimensions

Approx. 430 x 105 x 275 mm (w/h/d)
 ($16\frac{7}{8}$ x $4\frac{1}{4}$ x $10\frac{3}{4}$ inches)
 including projecting parts and controls

Weight

Approx. 5.5 kg (12 lbs 3 oz)

0 dB = 0.775 V

MODEL IDENTIFICATION

— Specification Label —

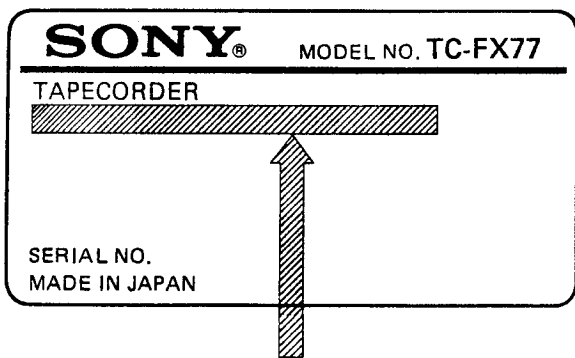

US, Canadian model: AC 120 V 60 Hz 26 W

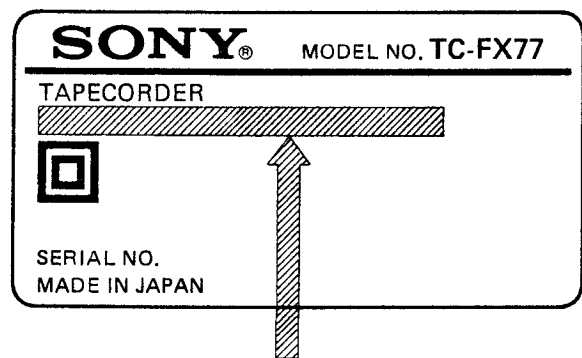

AEP model: AC 220 V ~ 50/60 Hz 26 W

UK model: AC 240 V ~ 50/60 Hz 26 W

Handling Precautions for MOS ICs

Generally, the insulation resistance of the oxide layer in MOS IC structures is very high, and the oxide layer is very thin. Because of this, it is possible that the static voltages usually present on clothes and the human body will be enough to generate a potential difference across the insulator, high enough to cause a breakdown of the insulating layer.

The following precautions should be taken while handling these ICs.

(Particular care should be taken under conditions of low humidity.)

3. Equalize any potential difference between the clothes, the tools in use, the work bench, the set being worked on, and the packaged IC by touching them all in succession with the hands or a conductive wire or tool.
4. The following are effective methods for handling ICs that remove the potential difference across the oxide layer.
 - Use a paper clip modified by soldering in a wire braid insert.

Precautions in Replacing MOS ICs

1. Store new ICs by inserting them into a urethane-polyester cushion (which is somewhat conductive), or wrapping it in aluminum foil, so that all the pins are at the same potential. (The ICs should be stored in that manner until mounted on the circuit board.)

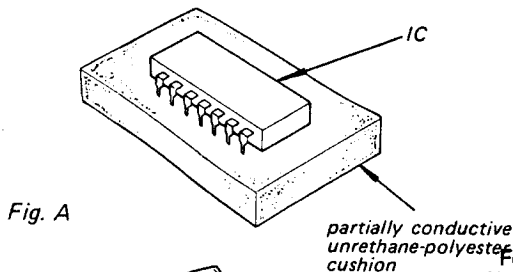

Fig. A

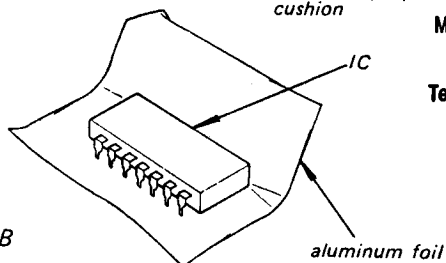

Fig. B

For Service Manuals Contact
MAURITRON TECHNICAL SERVICES
 8 Cherry Tree Rd, Chinnor
 Oxon OX9 4QY
 Tel:- 01844-351694 Fax:- 01844-352554
 Email:- enquiries@mauritron.co.uk

2. Check the soldering iron for possible power-line leakage current. Make sure that there is no leakage path by connecting an ohmmeter to the tip of the soldering iron and the plug as shown in Fig. C. If there is a leakage path, use some other soldering iron.

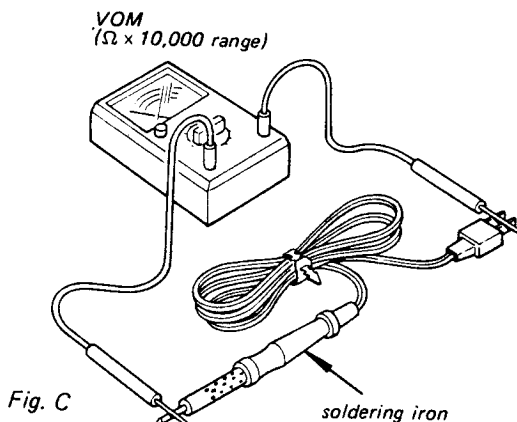

Fig. C

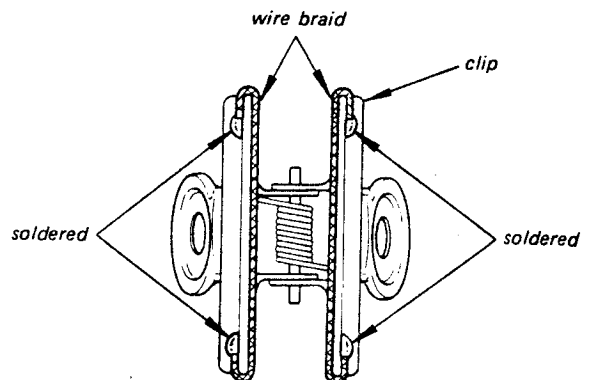

Fig. D

Make sure that there is no solder on the inside.

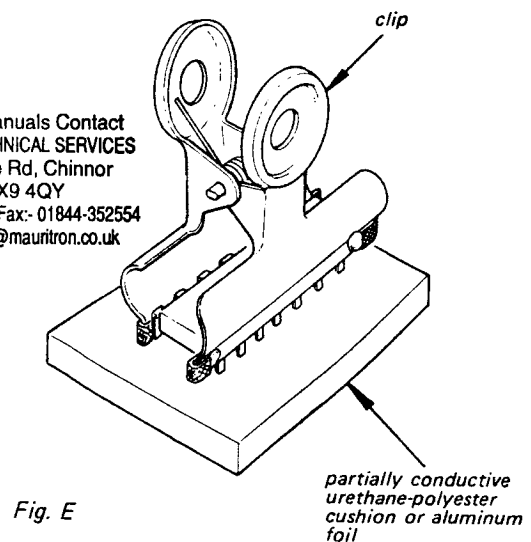

Fig. E

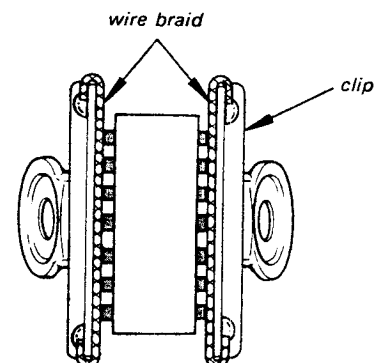

Fig. F

Make sure that all the pins are in contact with the wire braid (all the pins will then be at the same potential.).

- Take a short length of fine bare wire and wind it around the IC so that it shorts all the pins of the IC, while it is still in the urethane-polyester cushion or aluminum foil. This ensures that all the pins are at the same potential.

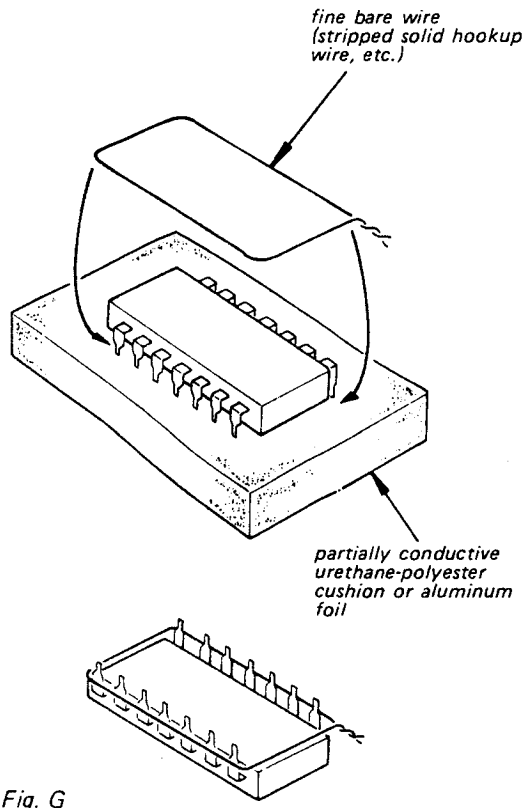

Fig. G

- When it is necessary to handle the IC with the fingers, do not touch any pin, and hold the IC at the ends of its plastic-package case as shown in Fig. H.

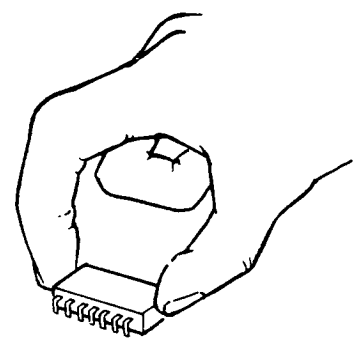

Fig. H

5. Method of Mounting

Insert the IC while holding it with the modified clip, and solder all the pins with the clip still shorting the pins. (Similarly, solder all the pins while the bare shorting wire is still wound around them.). Remove the clip or the bare shorting wire only after all the pins have been soldered.

Precaution while Checking C-MOS ICs

The C-MOS ICs (Complementary MOS) are MOS ICs that have their output sections made up of N-channel and P-channel push-pull stages to increase their speed of operation. If the output terminal of these ICs comes into contact with B+ or B- voltage, then the FET which is ON at that time will either become shorted or open.

This is valid for all the output sections that are connected together by the interconnections. Even the circuits that are physically separated (and not on the same board) can be destroyed simultaneously.

Example:

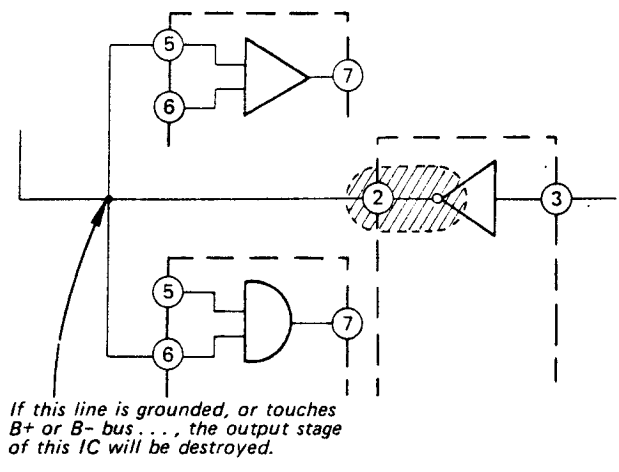
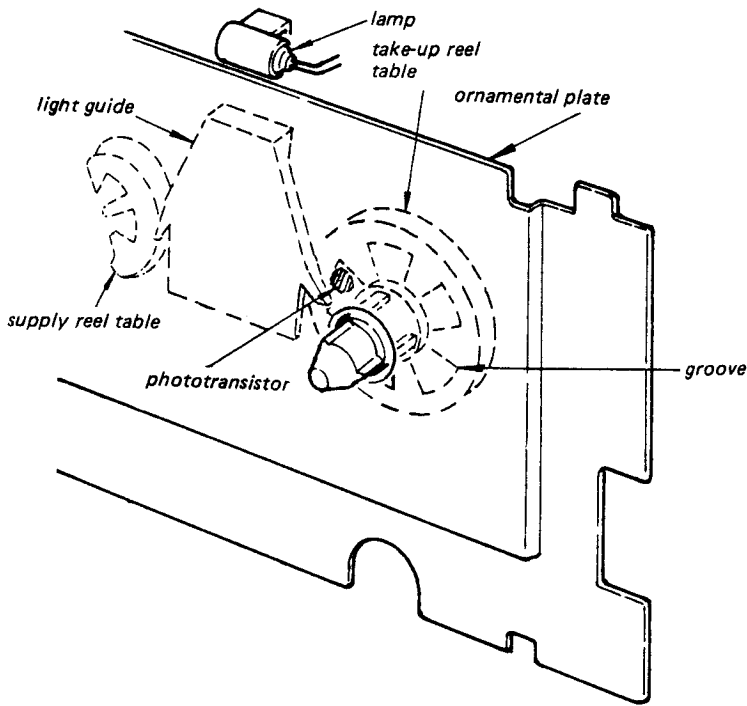

Fig. I

CAUTION ON REPAIRING AND SHUT-OFF DETECTION

This set performs the shut-off detection optically. There are five grooves on each reel table, the lamp light being transmitted with light guide on the back of the ornamental plate is to the phototransistor intermittently by the rotation of reel table.

Phototransistors Q802, 803 produce pulse waves by intermittent lights, which are input to mechanism controller of IC501 and the AMS counter of IC502 after shaped at IC507. Therefore, when it is necessary to repair by removing the ornamental plate, set the oscillator temporarily to the each input terminal of IC507 (input pattern on MD board or terminal 5, 6 of CNP510 on the system control board) not to operate the auto shut-off.



For Service Manuals Contact
MAURITRON TECHNICAL SERVICES
 8 Cherry Tree Rd, Chinnor
 Oxon OX9 4QY
 Tel:- 01844-351694 Fax:- 01844-352554
 Email:- enquiries@mauritron.co.uk

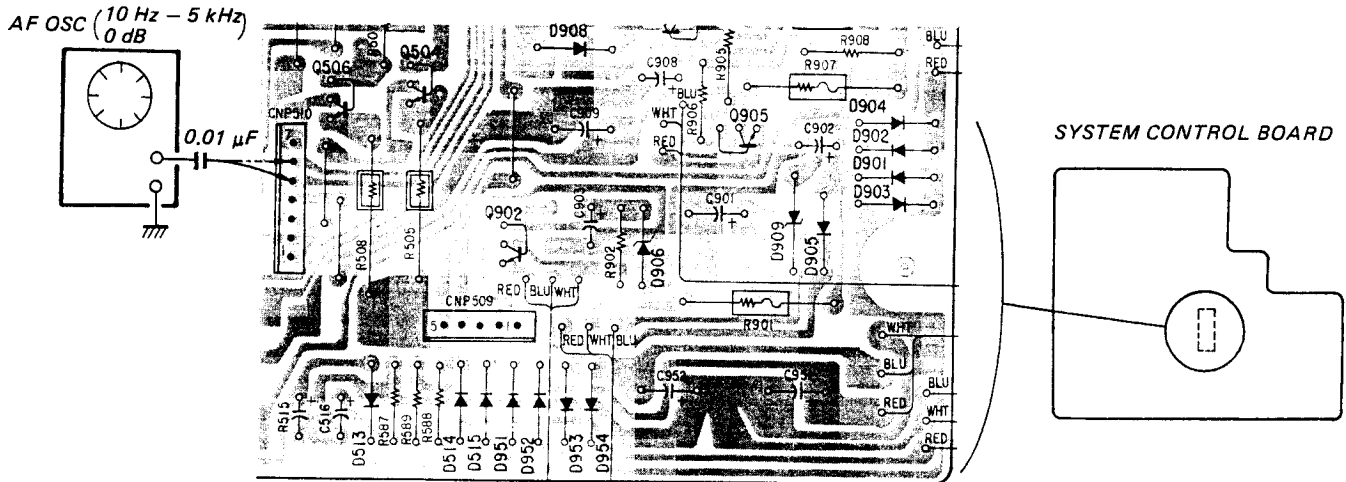

SECTION 1 OUTLINE

1-1. BLOCK DIAGRAM - Audio Section -

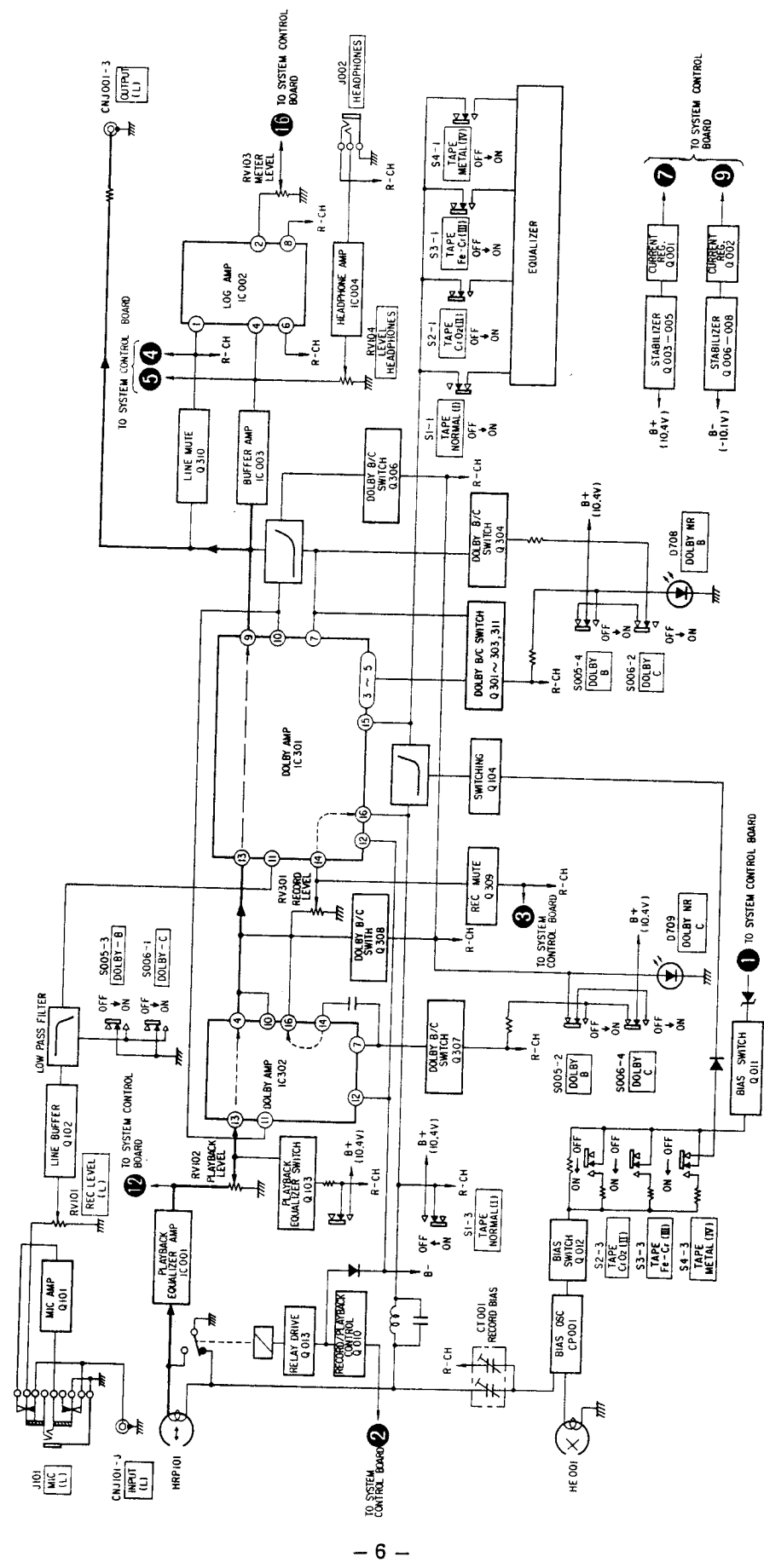

- System Control Section -

For Service Manuals Contact
 MAURITRON TECHNICAL SERVICES
 8 Cherry Tree Rd, Chinnor
 Oxon OX9 4QY
 Tel: 01844-351694 Fax: 01844-352554
 Email: enquiries@mauritron.co.uk

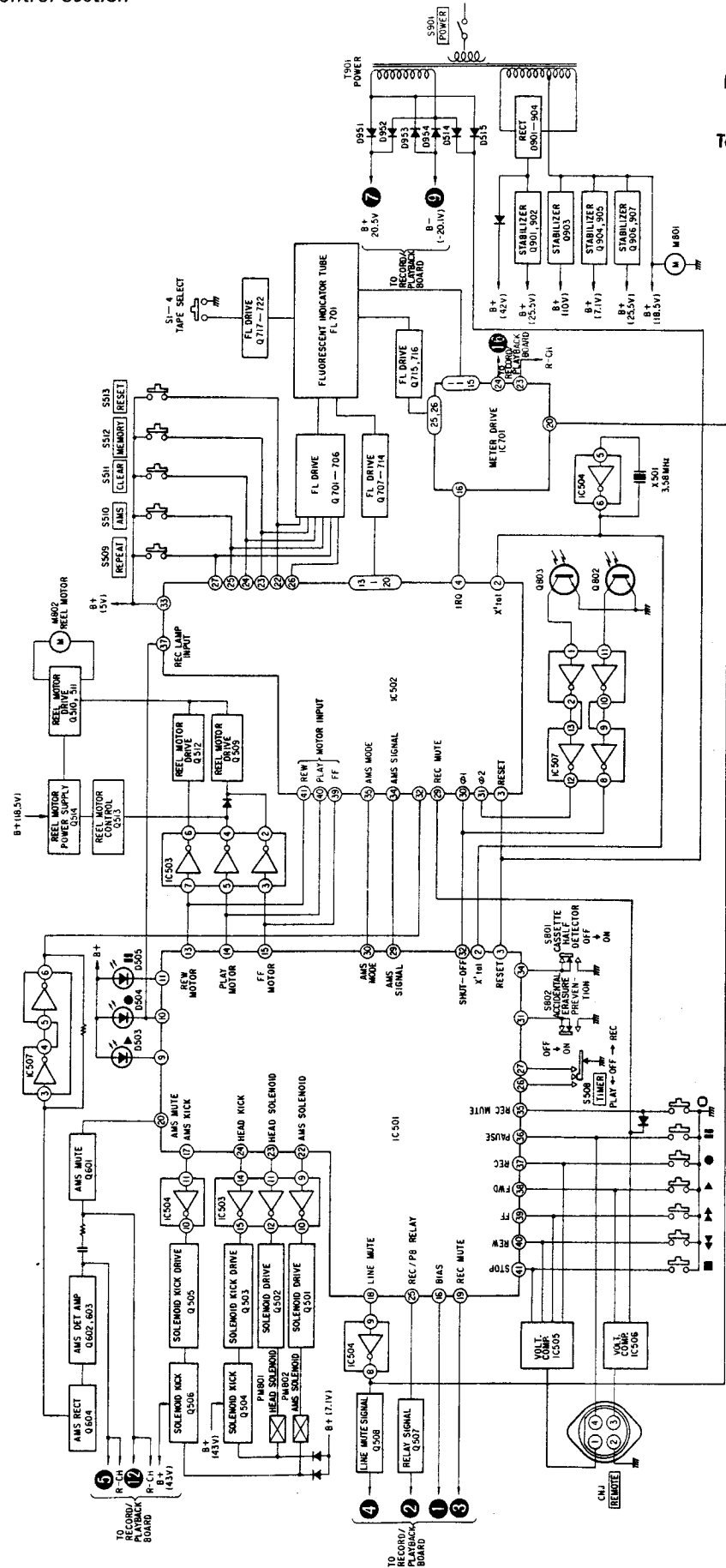

USING THE DIGITAL LINEAR COUNTER

The first two digits of this tape counter show the approximate recording or playback time in minutes, and the last two digits show the seconds.

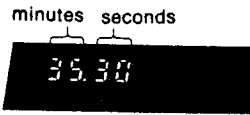

TO INDEX THE WHOLE TAPE

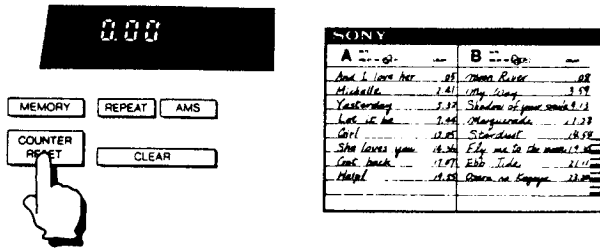

Before recording or playback, set the counter to "0.00" by pressing the COUNTER RESET button.

As the tape runs, the figures of the counter change. Note the numbers and the program being recorded or played back. Any point of the tape can thus be readily located later by reference to these numbers.

TO CHECK THE AVAILABLE RECORDING TIME ON ONE SIDE OF A CASSETTE

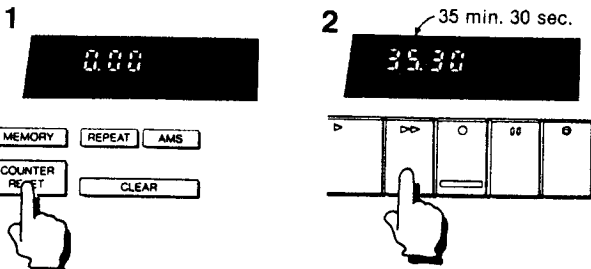

1 At the beginning of the tape, set the counter to "0.00".

2 Fast-forward the tape to the end. The digits will show the approximate available recording time.

TO DETERMINE THE REMAINING RECORDING TIME

1 Stop the tape at the point at which you wish to begin recording.

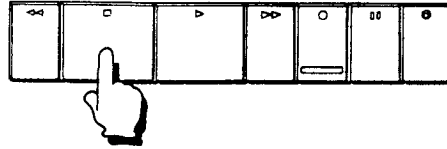

2 Set the counter to "0.00".

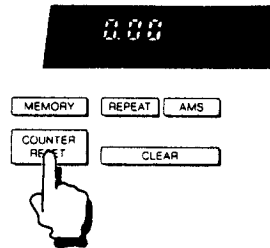

3 Activate the memory counter.

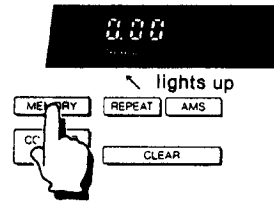

4 Fast-forward the tape to the end.

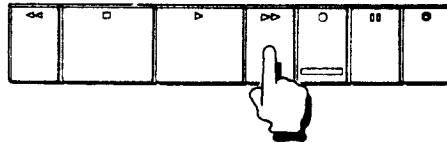

The digits will show the approximate remaining recording time.

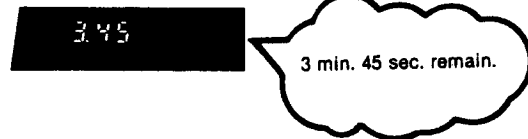

5 Rewind the tape. The tape will stop at "0.00".

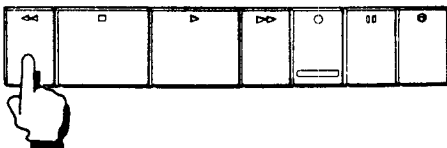

TO MONITOR THE REMAINING RECORDING TIME WHILE RECORDING—Using the minus display

This counter shows the recording or playback time from the "0.00" point preceded by a minus sign when the tape is rewound beyond "0.00".

1 Fast-forward the tape to the end.

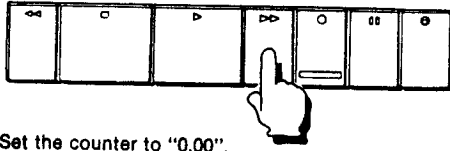

2 Set the counter to "0.00".



MEMORY REPEAT AMS

COUNTER CLEAR



3 Rewind the tape to the beginning. The digits will show the approximate recording time on one side of the cassette.

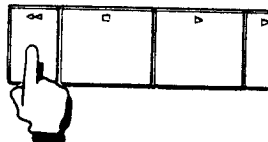

30 min. available



4 Start the recording.

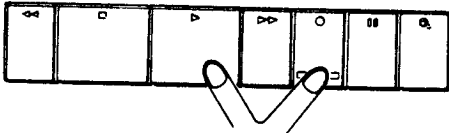

The digits will change from -30.00 to -29.59, -29.58 ... as the recording goes on, and you can monitor the remaining recording time at any point on the tape.

Note

Do not turn off the power while measuring the time because the numbers will return to "0.00" when the power is turned on again.

The accuracy of the counter

This counter is not actually a digital clock, so that the displayed figures are not exactly equal to the actual elapsed time. The accuracy will vary depending on the type of tape being used.

This counter has been designed using C-60 cassettes as the standard. Make sure that the displayed time is greater than the time required when using a C-46 cassette.

Difference between the counter indication and actual running time on one side of a cassette

↔ Sony BHF, AHF, CD-α and FeCr cassettes
 ↔ Sony METALLIC cassettes

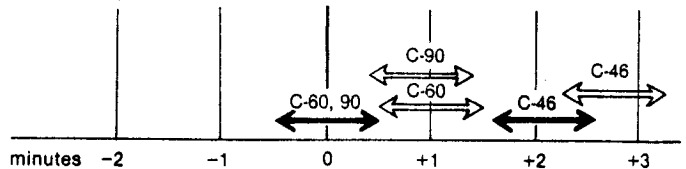

The counter indication is less than the actual tape running time. The counter indication is more than the actual tape running time.

WARNING THAT THE TAPE IS ABOUT TO END DURING RECORDING—The pre-end winker

When the tape approaches the end during recording, the digits of the counter will blink, warning that the tape is about to run out (We call this function the pre-end winker.) The blinking will begin 2 to 3 minutes before the end of the tape for a C-46 or C-60 cassette, and 3 to 5 minutes before the end of the tape for a C-90 cassette.

Note that the pre-end winker may not function when using a cassette whose hubs are very thick.

For Service Manuals Contact
MAURITRON TECHNICAL SERVICES
 8 Cherry Tree Rd, Chinnor
 Oxon OX9 4QY
 Tel: 01844-351694 Fax: 01844-352554
 Email: enquiries@mauritron.co.uk

Symbols in the Illustrations



Press the button.



Press both buttons at the same time.

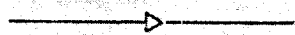

playback



rewind



stop

PROGRAMMING YOUR CASSETTE DECK

With this microprocessor-controlled cassette deck, you can easily locate any particular point on the tape, repeat a selection any number of times, stop playback at a particular point and more. Select the desired operation from the list below, then refer to the numbered selection for detailed instructions.

- To rewind the tape to the desired point **1 MEMORY STOP**
- To play from the beginning of the tape **2 AUTO PLAY**
- To play from a desired point **3 MEMORY PLAY**
- To play from the start of a desired selection **4 AMS (Automatic Music Sensor)**
- To repeat the playback of one side of a cassette from the beginning to the end **5 REPEAT**
- To repeat a favorite selection **6 AMS + REPEAT**
- To stop the playback at a particular point on the tape **7 ENDING CONTROL**
- To repeat an early part or a later part of the tape **8 MEMORY + REPEAT**
- To repeat an early part or a later part of a selection **9 AMS + MEMORY + REPEAT**

THE PROGRAMMING CONTROLS

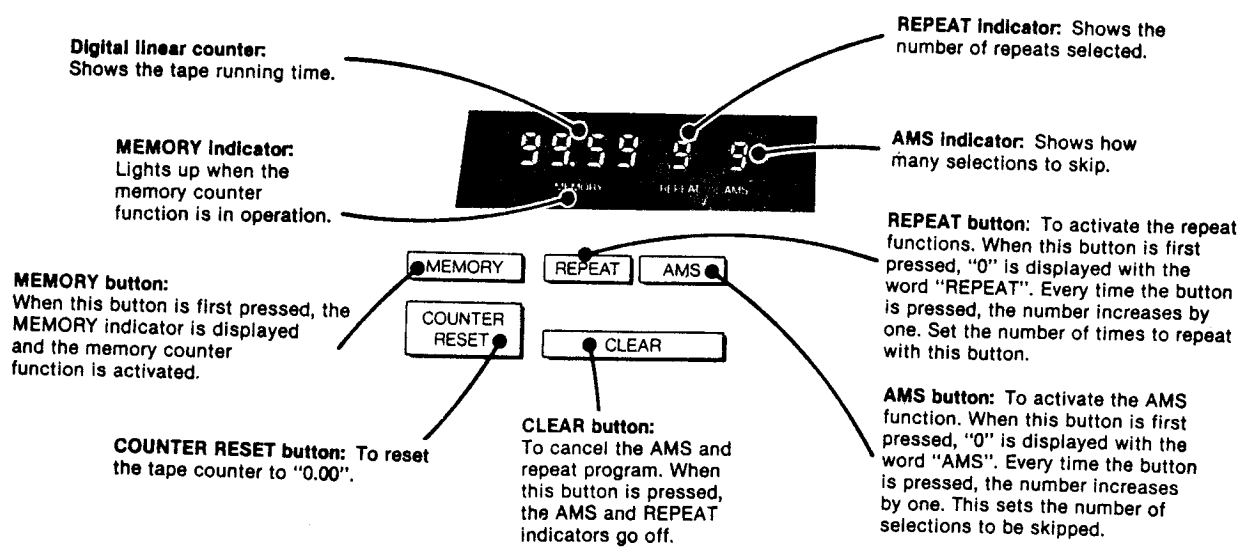

1 MEMORY STOP

To rewind the tape to the desired point

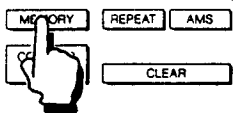
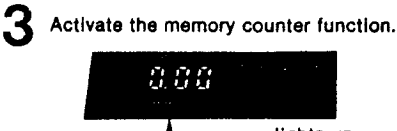
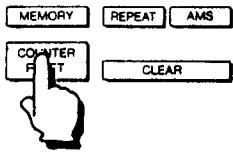
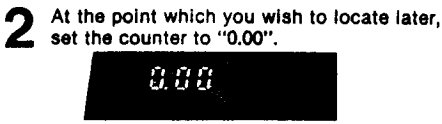
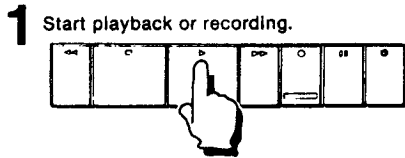

(If the MEMORY indicator is displayed, do not press the MEMORY button.)

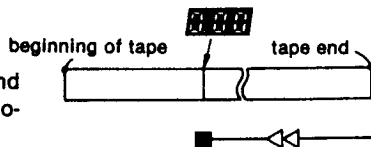
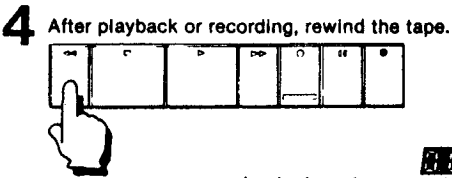

The tape begins to rewind and stops at the "0.00" automatically.

Why does the tape stop around "-0.01"?
—In order to avoid cutting off the starting point.

How does one rewind the tape further than "0.00"?
—Press the ◀ button again.

When should one press the MEMORY button?
—Any time. If the MEMORY indicator is displayed, the tape will stop or replay automatically at the "0.00" point.

2 AUTO PLAY

To play from the beginning of the tape

1 Cancel the previous AMS and repeat programs.

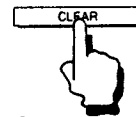

2 If the MEMORY indicator is displayed, cancel the memory counter function.

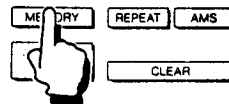

3 When you rewind the tape,

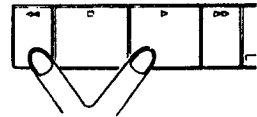

After the tape is completely rewound, the tape will automatically replay.

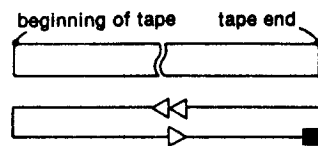

3 MEMORY PLAY

To play from a desired point

1 Start playback or recording.

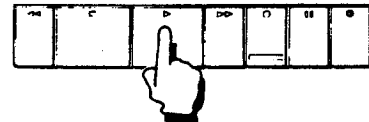

2 At the point from which you wish to listen to later,

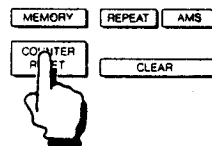

3 Activate the memory counter function.

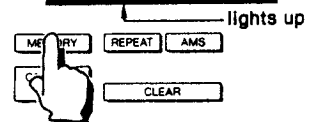
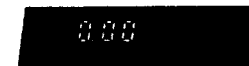

(If the MEMORY indicator is displayed, do not press the MEMORY button.)

4 After playback or recording, rewind the tape.

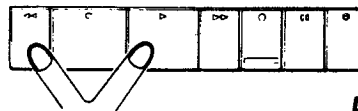

The tape will replay automatically after rewinding up to the "0.00" point.

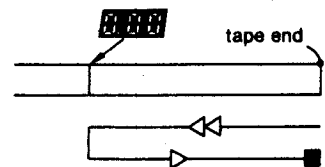

For Service Manuals Contact
MAURITRON TECHNICAL SERVICES
 8 Cherry Tree Rd, Chinnor
 Oxon OX9 4QY
 Tel: 01844-351694 Fax: 01844-352554
 Email: enquiries@mauritron.co.uk

1 AUTOMATIC MUSIC SENSOR (AMS) To play from the start of a desired selection

The Automatic Music Sensor locates the program selection you desire by skipping ahead (in the fast-forward mode) or going back past others (in the rewind mode), and plays back the selection automatically.

The AMS works by counting the blank spaces between selections.

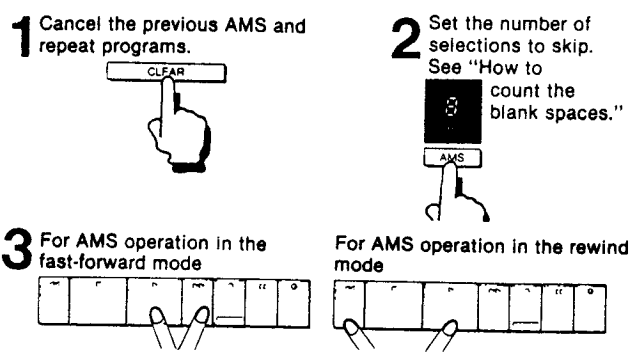

The AMS can locate a selection as far ahead as 9 selections or as far back as 8 selections. You can increase this capacity even further by pressing the AMS button when the AMS is in midsearch and has already passed a number of selections.

How to count the blank spaces
The number to be set in the display window by pressing the AMS button is the number of blanks from the present position to the blank preceding the desired selection.

To locate the 3rd selection ahead from the selection being played, for example, set the number "3" in the display window so that the AMS finds the 3rd blank space. To locate the 3rd selection back, set "3" so that the AMS finds the 4th blank space.

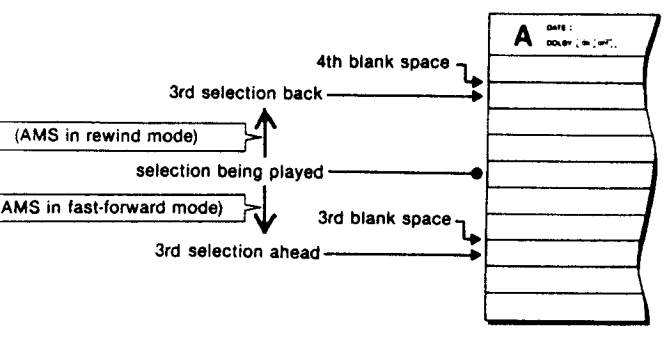

If the present tape position is at one of the blank spaces, that blank space should not be counted when you set the AMS program.

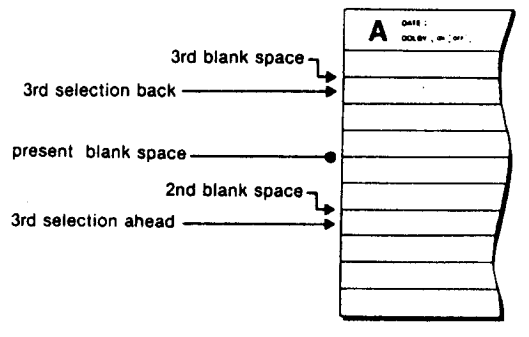

"0" display

When you start AMS operation with "0" in the display window, playback starts from the beginning of the selection detected first. Set to "0" to quickly locate the beginning of the next selection from the blank space in the fast-forward mode.

To assure AMS operation on recorded tape

Since AMS works by searching out the blank spaces on a tape, it may not operate if there is noise in the space between selections, or if the space is too short to be detected.

The record muting facility of this cassette deck can make a four second blank space that will assure AMS operation on any recorded tape.

Note on AMS operation

If the recorded music includes a long pause, or if it continues for a time at sufficiently low volume, as may happen for instance with classical music, the AMS will treat this space as a blank.

Using a remote control unit

The **M** (record muting) button of the RM-50 and RM-80 remote control units has the same function as the AMS button in the AMS operation. You can set the appropriate number in the display window remotely by pressing the **M** button of the remote control unit connected to this cassette deck.

For Service Manuals Contact
MAURITRON TECHNICAL SERVICES
 8 Cherry Tree Rd, Chinnor
 Oxon OX9 4QY
 Tel:- 01844-351694 Fax:- 01844-352554
 Email:- enquiries@mauritron.co.uk

5 REPEAT

To repeat the playback of one side of a cassette from the beginning to the end

1 Cancel the previous AMS and repeat programs.

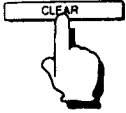

2 Set to the number of times you wish it to repeat.



3 Playback.

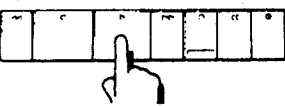

or Rewind.

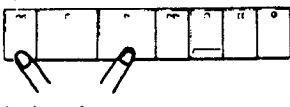

When the tape reaches its end after playing back, it stops, then rewinds automatically to the beginning and starts playback again. The tape repeats this cycle the number of times you have set with the REPEAT button, then it stops.

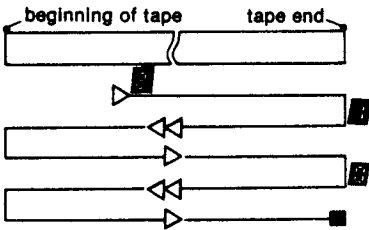

6 AMS + REPEAT

To repeat a favorite selection

1 Cancel the previous AMS and repeat programs.



2 To repeat the selection now being played back:



To skip up to the desired selection and repeat it:



3 Playback.

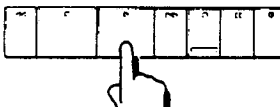

Rewind or fast-forward.

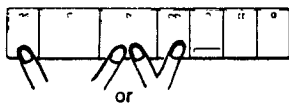

4 Set to the number of times you wish it to repeat.



When the playback of that selection ends, the tape rewinds back to the beginning of the selection, then repeats playback. The tape repeats this cycle the number of times you have set with the AMS button, then it stops.

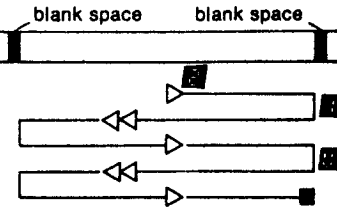

7 ENDING CONTROL

To stop the playback at a particular point

To stop the playback at the end of a selection
 —Using the AMS function

1 Cancel the previous AMS and repeat programs.

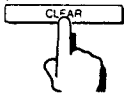

2 If the MEMORY indicator is displayed, cancel the memory counter function.



3 Set to the number of selections you wish to listen to minus 1.



(For example, to listen to 4 selections, set to 3)

4 Set the REPEAT indicator to "0".



5 Play back.



beginning of tape

blank space



The AMS counts the blank spaces as the tape is played back, and the tape stops automatically after the preset number of selections have been played back.

To stop the playback in the middle of a selection
 —Using the memory counter function

1 Cancel the previous AMS and repeat programs.

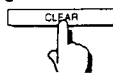

2 When the tape reaches the end of the part you wish to listen to later, stop the tape.

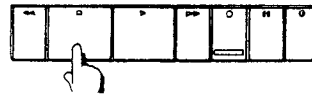

3 Set the counter to "0.00".



4 Activate the memory counter function.

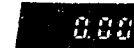

5 Set the repeat indicator to "0".



6 Rewind.

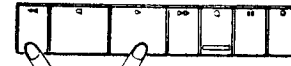

beginning of tape

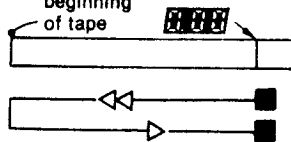

After the tape is completely rewound, the tape will automatically replay and stop at the point "0.00".

For Service Manuals Contact
MAURITRON TECHNICAL SERVICES
 8 Cherry Tree Rd, Chinnor
 Oxon OX9 4QY
 Tel:- 01844-351694 Fax:- 01844-352554
 Email:- enquiries@mauritron.co.uk

8 MEMORY + REPEAT

To repeat an early part or a later part of the tape

1 Cancel the previous AMS and repeat programs.

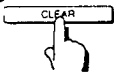

2 Start playback.

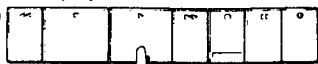

3 When the tape reaches the end of the part you wish to repeat, stop the tape.

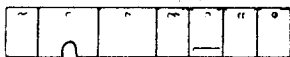

4 Set the counter to "0.00".



5 Activate the memory counter function.



6 Set to the number of times you wish it to repeat minus 1.



(For example, to repeat twice, set to 1.)

7 Rewind.

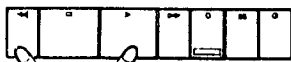

When the tape is played back up to the "0.00" point, the tape rewinds to its beginning, then playback resumes. The tape repeats this cycle the number of times you have set with the REPEAT button, then it stops.

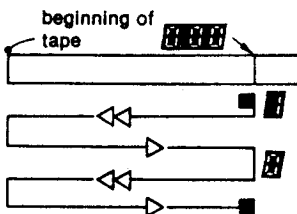

1 Cancel the previous AMS and repeat programs.

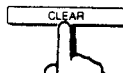

2 Start playback.

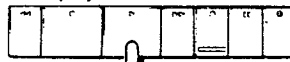

3 When the tape reaches the point you want to start repeat play, set the counter to "0.00".



4 Activate the memory counter function.



5 Set to the number of times you wish it to repeat.





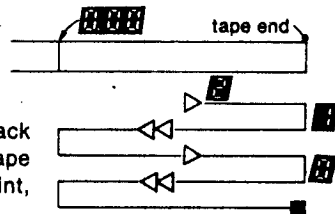

(For example, to repeat twice, set to "2".)

When the tape is played back up to the end, the tape rewinds to the "0.00" point, then playback resumes. The tape repeats this cycle the number of times you have set with the REPEAT button, then it stops.



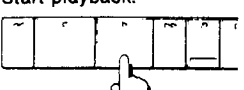
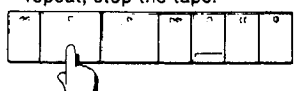
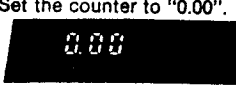

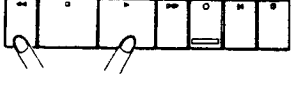

9 AMS + MEMORY + REPEAT
 To repeat an early part or a later part of a selection

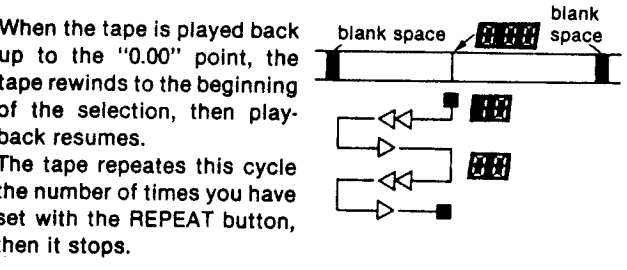
To repeat an early part of a selection

- 1 Start playback. 
- 2 When the tape reaches the end of the part you wish to repeat, stop the tape. 
- 3 Set the counter to "0.00". 
- 4 Activate the memory counter function. 
- 5 Set to the number of times you wish it to repeat minus 1.  (For example, to repeat twice, set to "1".)
- 6 Set the AMS to "0". 
- 7 Rewind. 

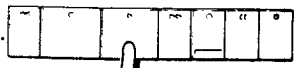

To repeat a later part of a selection

- 1 Start playback. 
- 2 When the tape reaches the point where you wish to start repeat-play, set the counter to "0.00". 
- 3 Activate the memory counter function. 
- 4 Set to the number of times you wish it to repeat. 
- 5 Set the AMS to "0". 

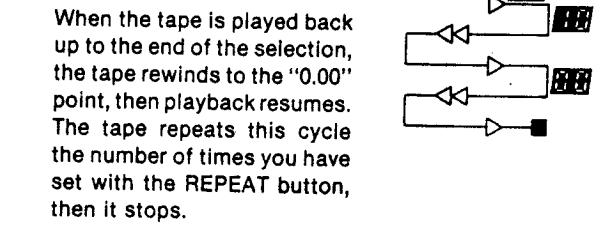

For Service Manuals Contact
MAURITRON TECHNICAL SERVICES
 8 Cherry Tree Rd, Chinnor
 Oxon OX9 4QY
 Tel:- 01844-351694 Fax:- 01844-352554
 Email:- enquires@mauritron.co.uk

SECTION 2 DISASSEMBLY

2-1. REMOVAL

Follow the disassembly procedure in the numerical order given.

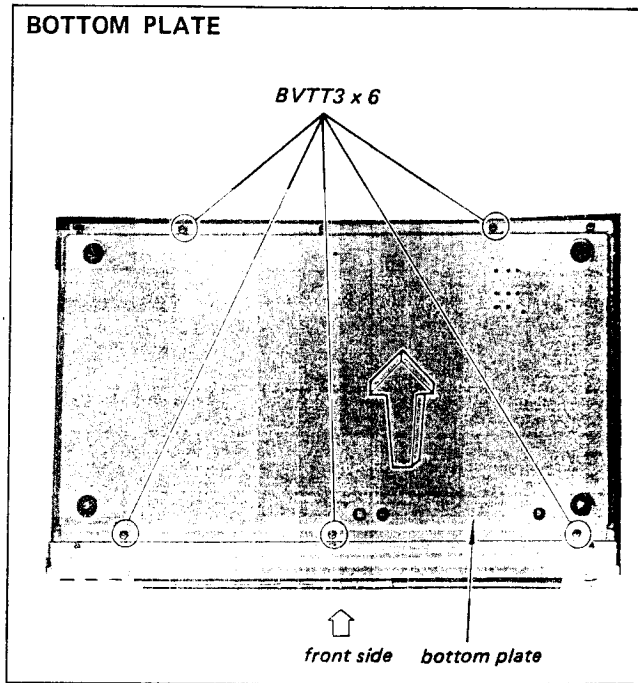
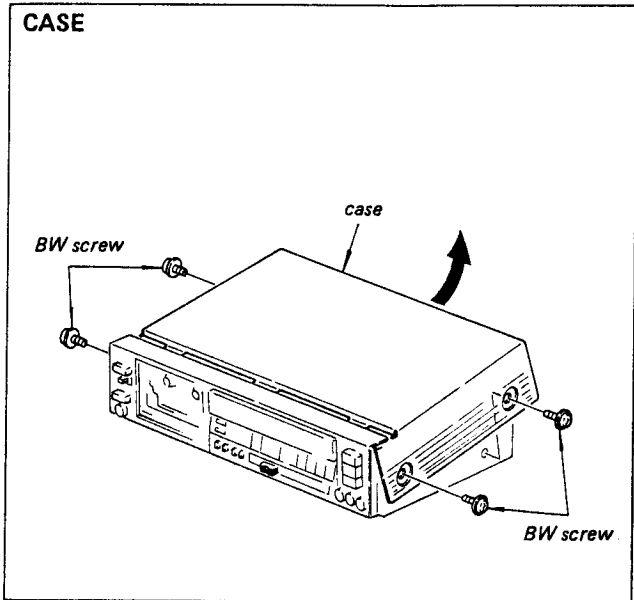

The conductor side of RECORD/PLAYBACK board and SYSTEM CONTROL board can be checked.

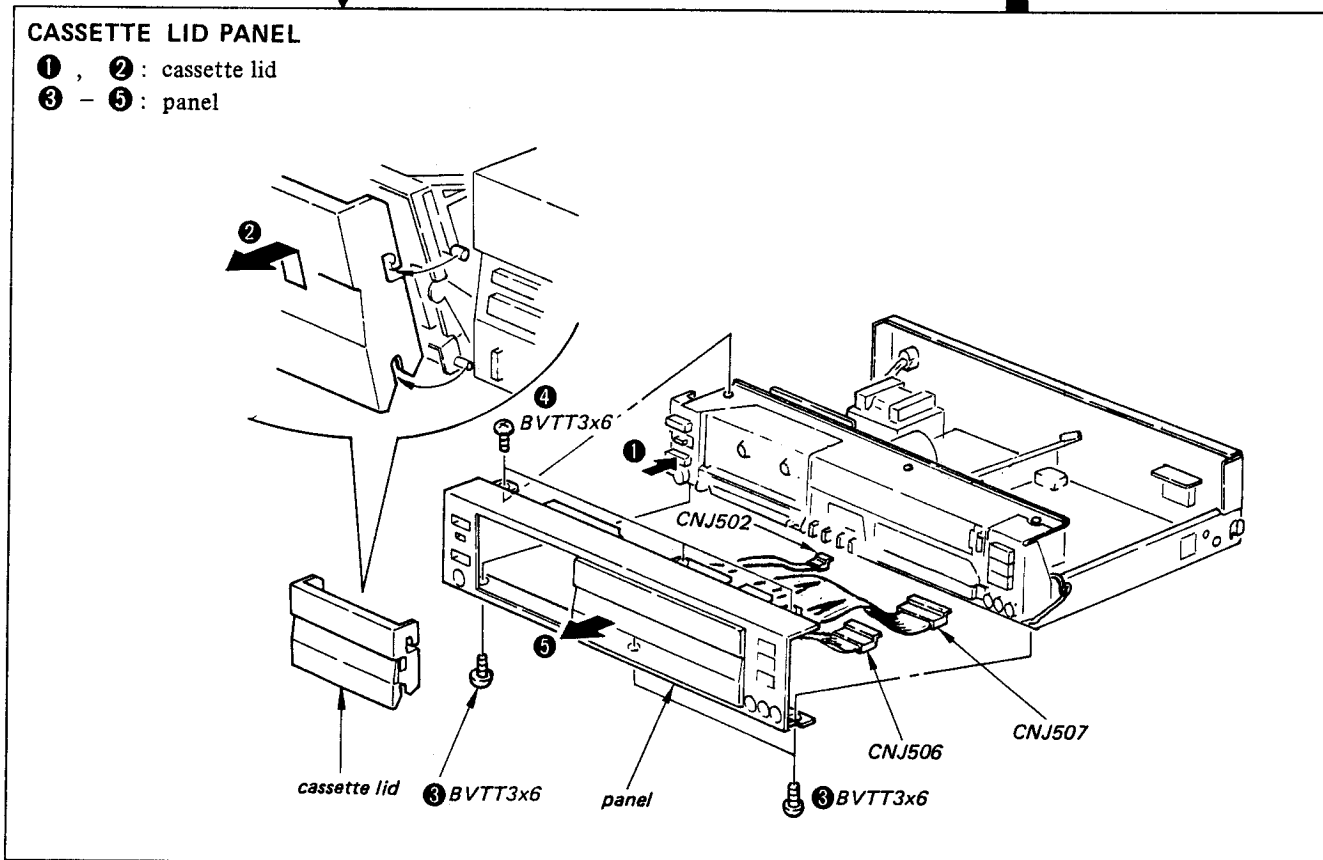

DECK MECHANISM

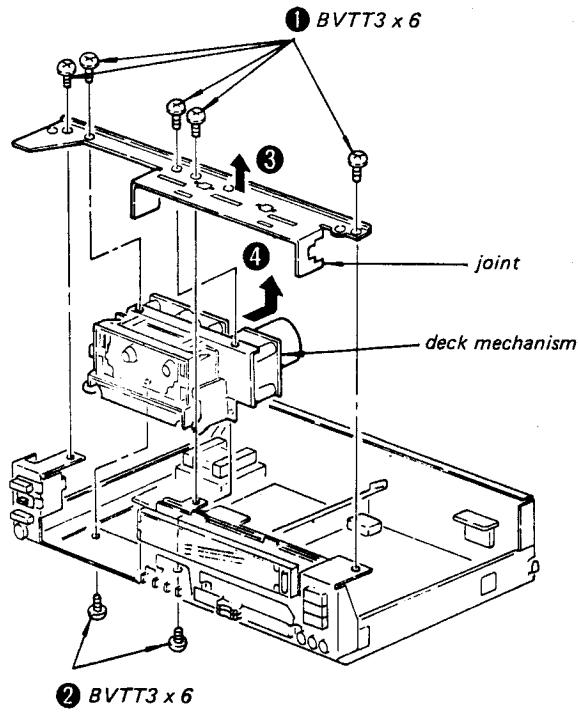

For Service Manuals Contact
MAURITRON TECHNICAL SERVICES
8 Cherry Tree Rd, Chinnor
Oxon OX9 4QY
Tel:- 01844-351694 Fax:- 01844-352554
Email:- enquiries@mauritron.co.uk



METER BOARD

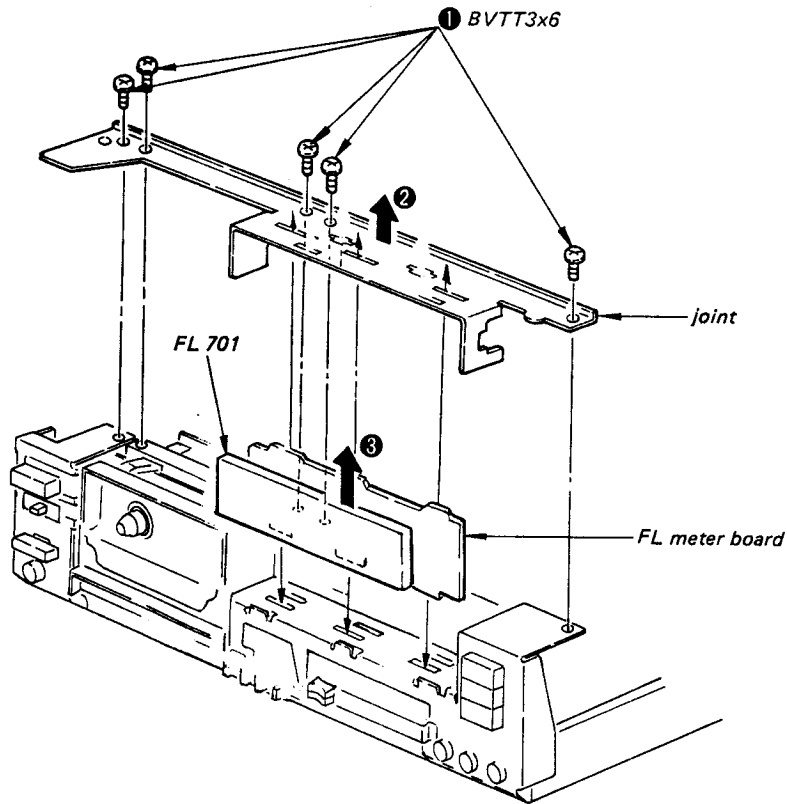

CASSETTE-ORNAMENT PLATE

Note: This set uses a newly-developed cassette-ornament plate. This plate does not need screws to be installed. So no care is exercised about the screws in this plate-mounting system.

- 1 Press the ejection button and open the cassette lid.
- 2 Remove the cassette lid. Remove the tape cassette from the cassette holder if any.
- 3 Release the two claws from the cassette-ornament plate at both the top corners.
- 4 Depress the two slide-switch levers at the inside of the set and remove the cassette-ornament plate.
(Alternatively, push the two slide-switch levers up from inside of the cassette compartment, and remove the cassette-ornament plate.)
- 5 When reinstalling the cassette-ornament plate, perform the steps in a reverse manner.

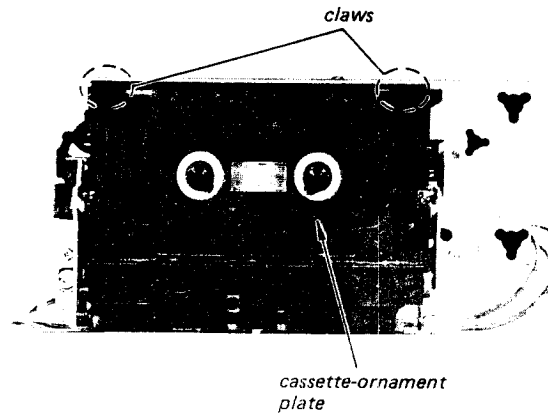

**SELECT TUNE LEVER/BRAKE PLATE ASS'Y/
SWITCH BOARD**

Select tune lever: ① ②

Brake plate ass'y: ① - ④

Switch board: ① - ⑨

Note: Be sure to tighten the screws ⑥ - ⑨ in numerical order given. Otherwise motor position may be displaced and decrease the performance.

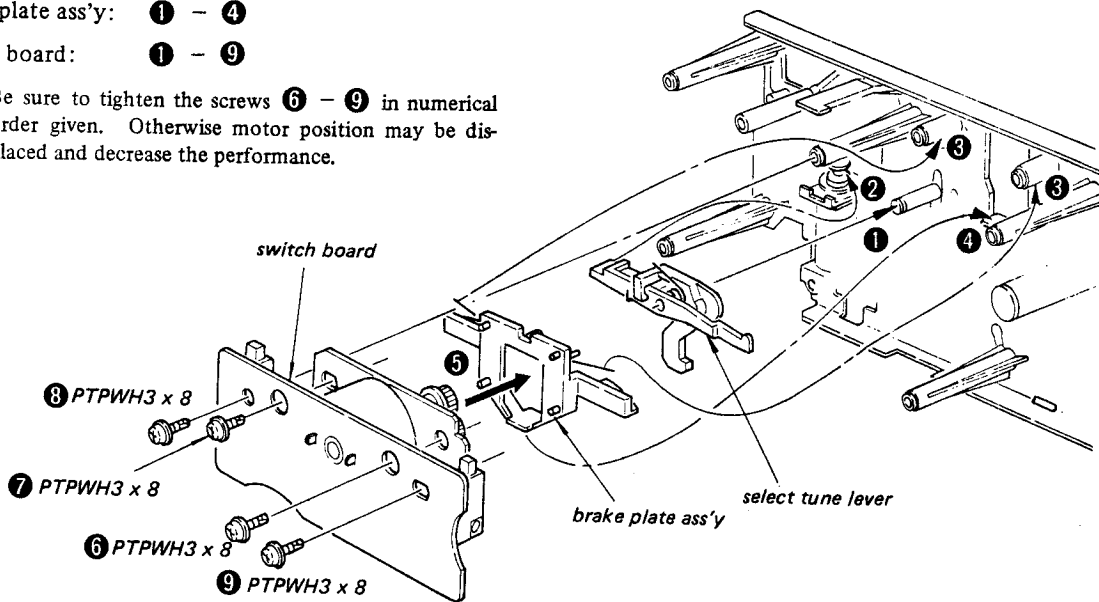

NOTE ON CASSETTE HOLDER INSTALLATION

LOCK LEVER/FULCRUM PLATE (LEFT)

- 1 Push up the REC detection lever and set the lock lever to positions 2, 3.
- 4 Fit the hole in the fulcrum plate (left) over the projection of mechanism chassis.
- 5 Tighten the screw (BVTT2.6 x 5).
- 6 Hook the spring onto the claw of fulcrum plate (left).

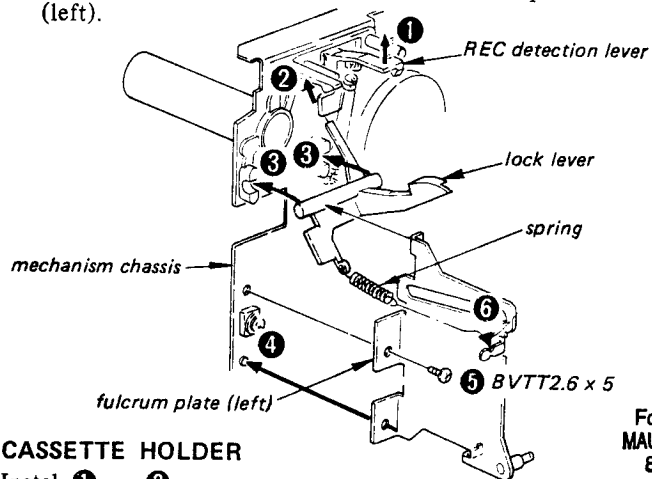

CASSETTE HOLDER

Instal 1 - 3.

Hook the spring to positions 4, 5.

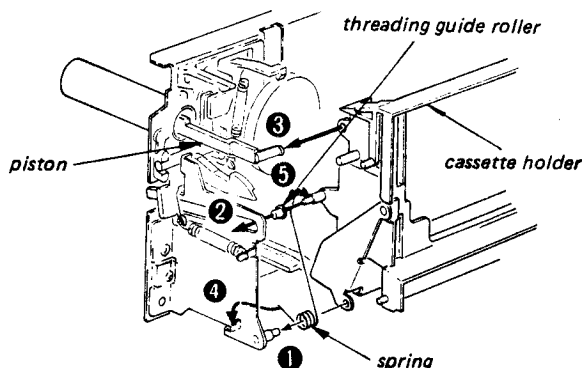

FULCRUM PLATE (RIGHT)

Install 1, 2.

- 3 Fit the hole in the fulcrum plate (right) over the projection of mechanism chassis.
- 4 Tighten the screw (BVTT2.6 x 5).

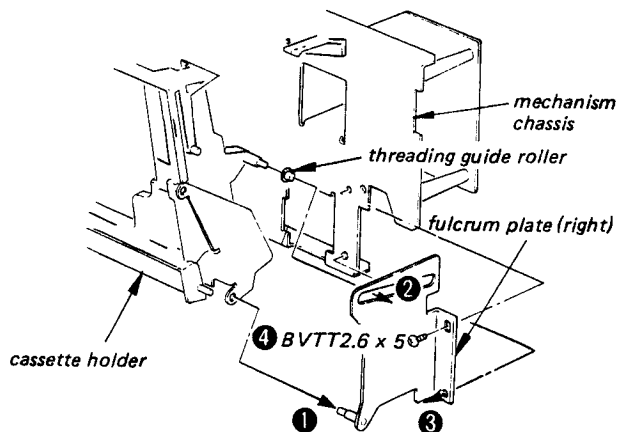

DECK-MECHANISM'S PHOTOGRAPHS

1. Top View with Cassette Holder closed:

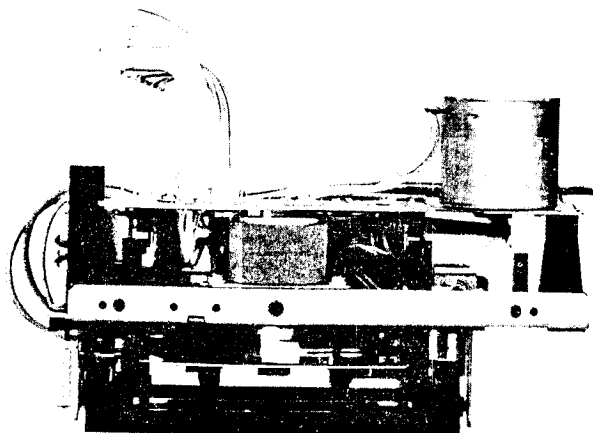

2. Bottom View with Cassette Holder closed:

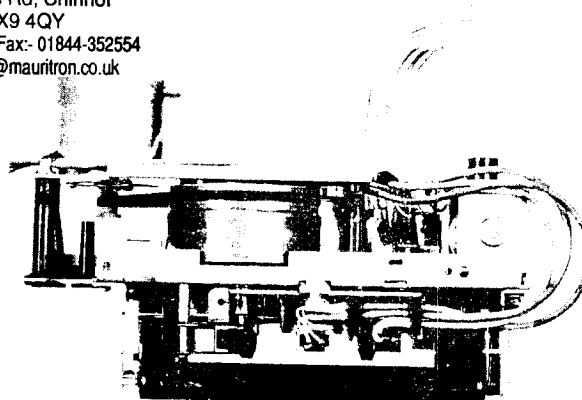

3. Left Side View with Cassette Holder closed:

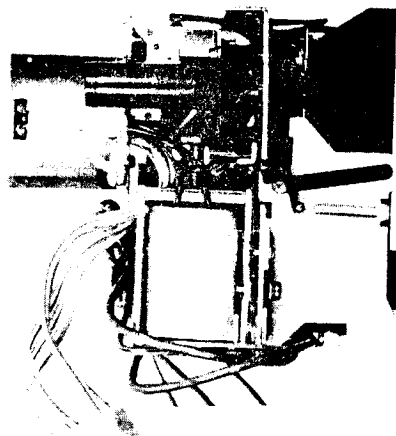

For Service Manuals Contact
MAURITRON TECHNICAL SERVICES
 8 Cherry Tree Rd, Chinnor
 Oxon OX9 4QY
 Tel: 01844-351694 Fax: 01844-352554
 Email: enquiries@mauritron.co.uk

4. Right Side View with Cassette Holder closed:

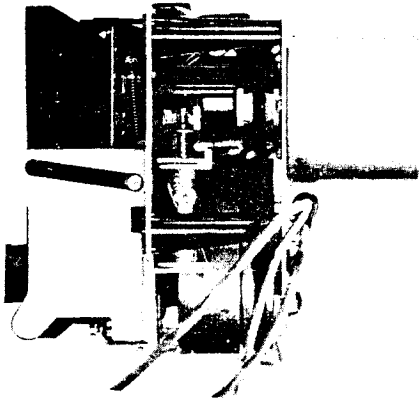

7. Rear View

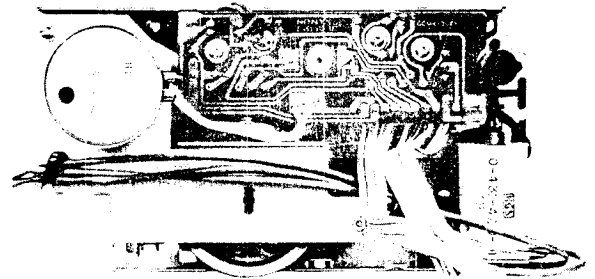

5. Front View with Cassette Holder removed:

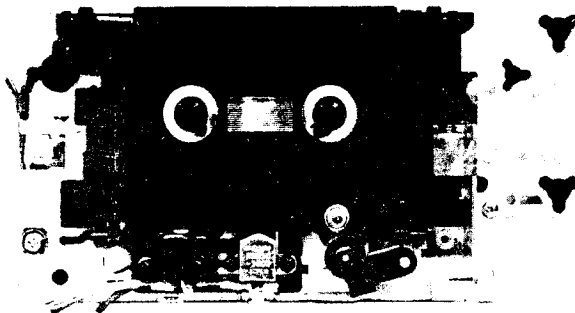

8. Rear View with Thrust Retainer and DC Motor removed:

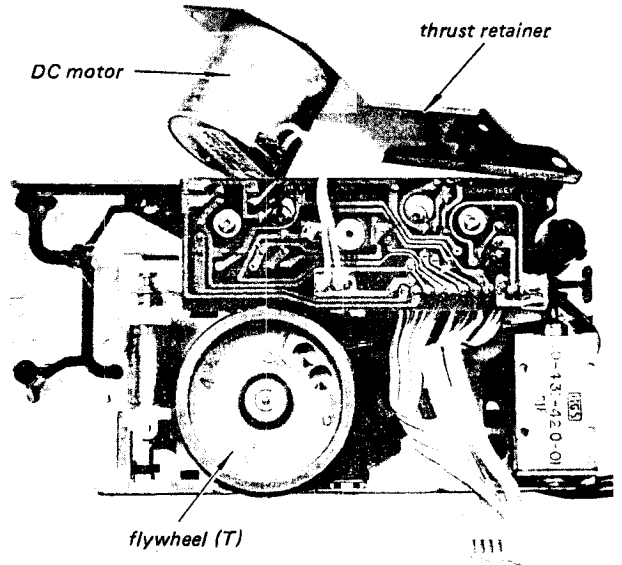

6. Front View with Cassette Holder and Cassette-Ornament Plate removed:

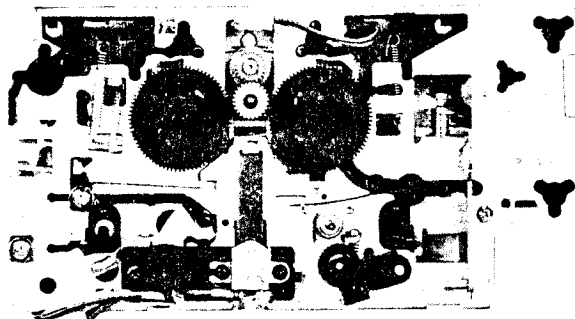

9. Rear View with Switch Board and Flywheel (T) removed:

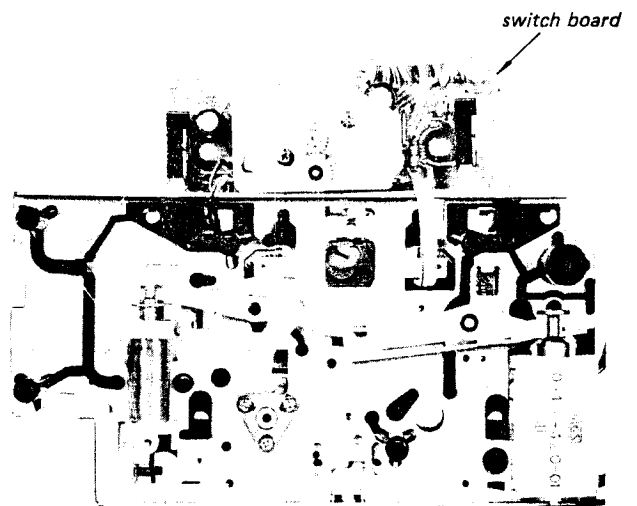

SECTION 3 ADJUSTMENTS

3-1. MECHANICAL ADJUSTMENTS

PRECAUTION

1. Clean the following parts with a denatured-alcohol-moistened swab:

record/playback head	pinch roller
erase head	rubber belts
capstan	idlers
2. Demagnetize the record/playback head with a head demagnetizer.
3. Do not use a magnetized screwdriver for the adjustments.
4. After the adjustments, apply suitable locking compound to the parts adjusted.
5. The adjustments should be performed with the rated power supply voltage unless otherwise noted.

Torque Measurement and Back Tension Torque Adjustment

Torque	Torque meter	Meter reading
Forward	CQ-102C	30-60 g · cm (0.41-0.83 oz · inch)
Back tension	CQ-102C	2.5-4.5 g · cm (0.04-0.06 oz · inch)

2. If the specified back-tension torque is not obtained, change the hooking position of the spring.

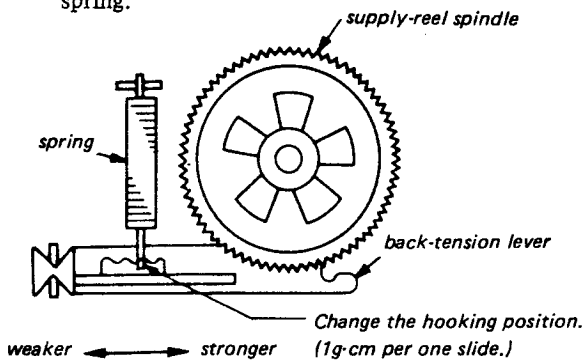

Confirmation:

Torque	Torque meter	Meter reading
FF REW	CQ201B	100-160 g · cm (1.38-2.22 oz · inch)

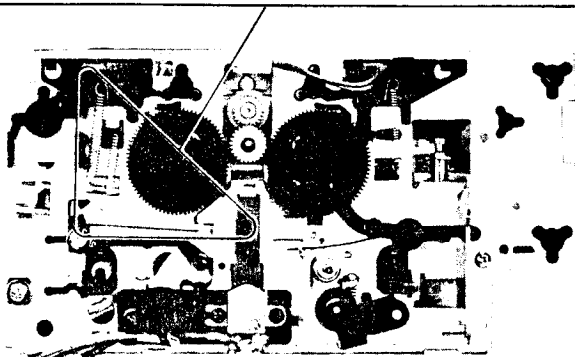

Head Height Adjustment

1. Prepare an adjustment cassette as shown below.

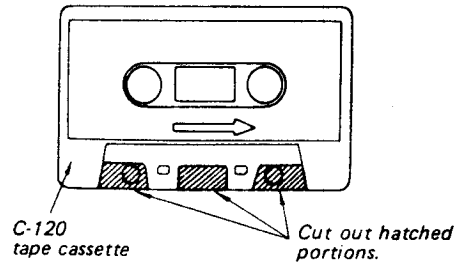

2. In playback mode and viewing from the front, adjust the head heights by using the adjustment screw A, B, C, to eliminate tape curl and tape twist at portions shown by arrow (*).
3.
 - a) Remove the tape curl at the erase head guides by turning the screw A.
 - b) Remove the tape curl at the record/playback head guides by turning the screws B and C by the same amount of angle in the same direction.
 - c) After the adjustment, apply suitable locking compound to the screws.

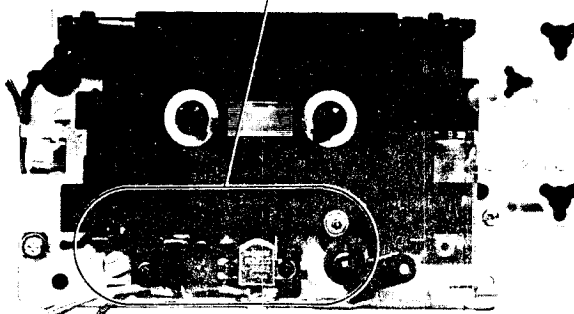
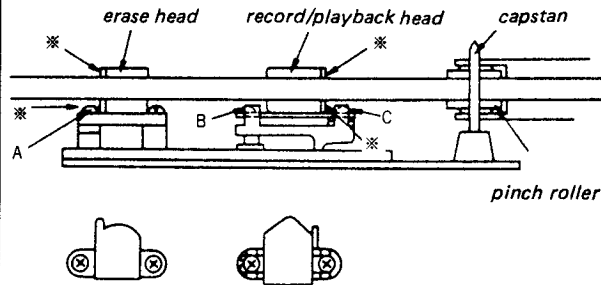

For Service Manuals Contact
MAURITRON TECHNICAL SERVICES
 8 Cherry Tree Rd, Chinnor
 Oxon OX9 4QY
 Tel:- 01844-351894 Fax:- 01844-352554
 Email:- enquiries@mauritron.co.uk

FR Gear Height Adjustment

— Stop Mode —

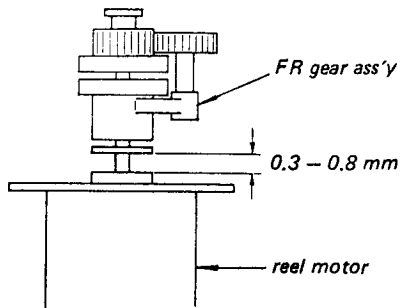

Motor Pulley Height Adjustment

— Stop Mode —

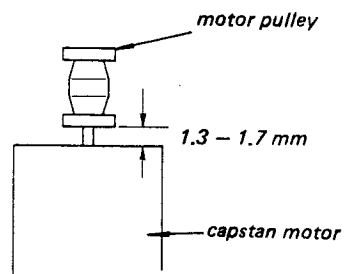

For Service Manuals Contact
MAURITRON TECHNICAL SERVICES
 8 Cherry Tree Rd, Chinnor
 Oxon OX9 4QY
 Tel:- 01844-351694 Fax:- 01844-352554
 Email:- enquiries@mauritron.co.uk

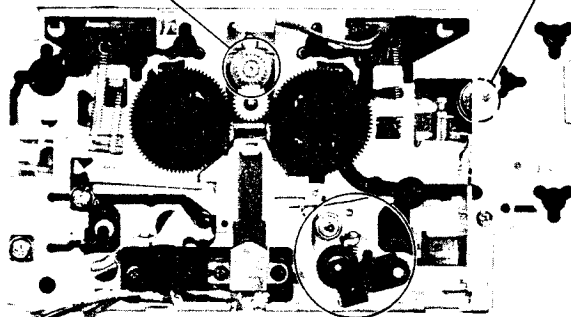

Pinch Roller Pressure Adjustment

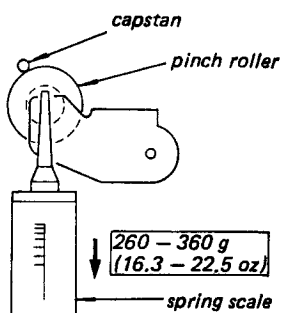

Procedure:

1. Clean the pinch roller and the capstan.
2. Set the unit to the forward mode. Measure the pinch roller pressure by using the spring scale. Read the spring scale just when the pinch roller stops rotating without contacting the capstan.

3-2. ELECTRICAL ADJUSTMENTS

Note: The adjustment should be performed in the order given in this service manual. The adjustments should be performed for both L-CH and R-CH.

- Set the TAPE switches according to the tape as follows.

Tape	TAPE switch
CS-10	TYPE I
CS-25	TYPE II
CS-30	TYPE III
CS-40	TYPE IV

- Switches and controls should be set as follows unless otherwise specified.

DOLBY NR switch : OFF
 TAPE switch : TYPE I
 TIMER switch: OFF

- Standard Record :

Deliver the standard input signal level to the input jack and set the REC LEVEL control to obtain the standard output signal level.

Standard Input Level

	MIC	LINE IN
source impedance	300Ω	10kΩ
input level	0.77mV (-60dB)	0.25V (-10dB)

Standard Output Level

	HEADPHONES	LINE OUT
load impedance	8Ω	47kΩ
output level	31 mV (-26dB)	0.435V (-5dB)

Capstan Motor Speed Adjustment

Procedure:

Mode: playback

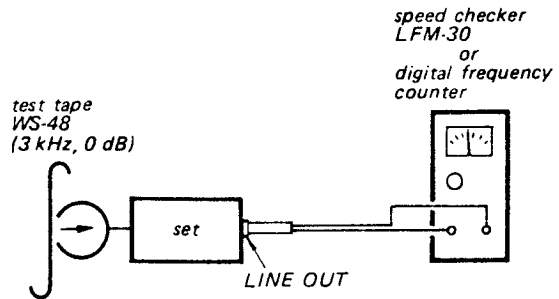

Specification:

Speed checker	Digital frequency counter
-0.17 ~ +0.17%	2.995 ~ 3.005Hz

Frequency difference between the beginning and the end of the tape should be within 0.34% (10Hz).

Adjustment Location:

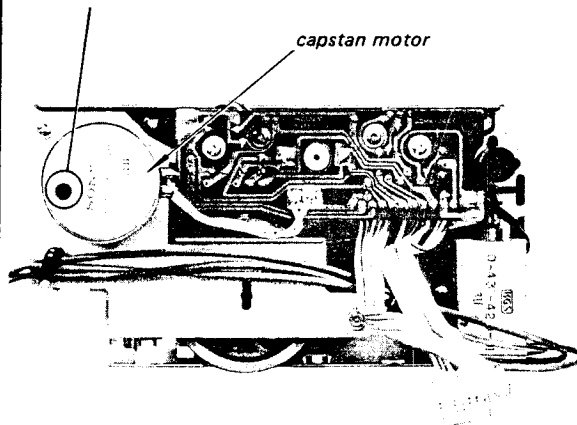

Adjust the speed by using screwdriver. When turning the screw clockwise, speed is faster.

Record/Playback Head Azimuth Adjustment

Procedure:

1. Mode: playback

test tape
P-4-A82S
(6.3 kHz, -10 dB)

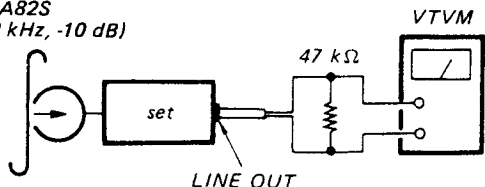

2. Turn the adjustment screw for the maximum output levels. If these levels do not match, turn the adjustment screw until both of output levels match together within 0.5 dB.

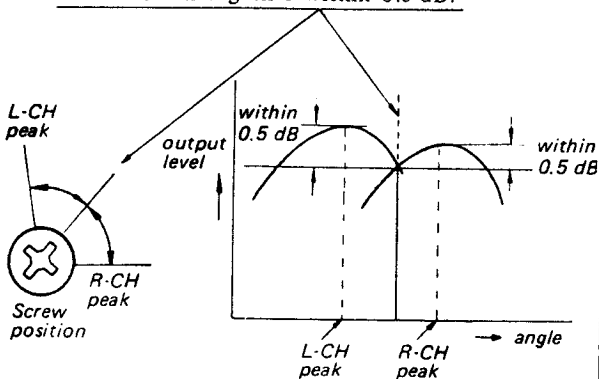

3. Phase Check
Mode: playback

test
P-4-A82S
(6.3 kHz, -10 dB)

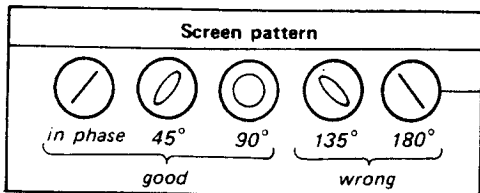
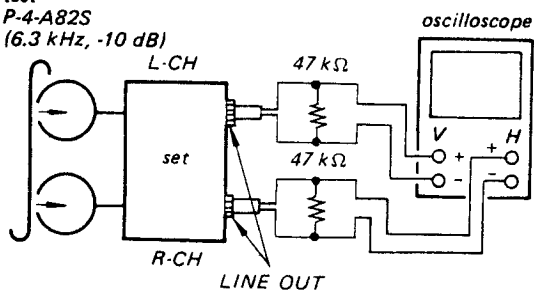

Adjustment Location:

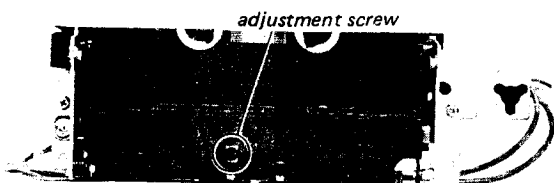

Playback Level Adjustment

Procedure:

Mode :playback

For Service Manuals Contact
MAURITRON TECHNICAL SERVICES
8 Cherry Tree Rd, Chinnor
Oxon OX9 4QY
Tel:- 01844-351694 Fax:- 01844-352554
Email:- enquiries@mauriron.co.uk

test tape
P-4-L81
(333 Hz, 0 dB)

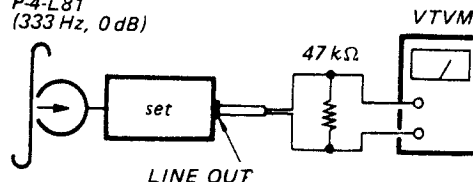

Specification:

LINE OUT level : 0.52 ~ 0.58 V
(-3.5 ~ -2.5 dB)

Level difference between channels :
less than 0.5 dB

Check that the LINE OUT level does not change in playback mode while changing the mode from playback to stop several times.

Adjustment Location:

- record/playback board -

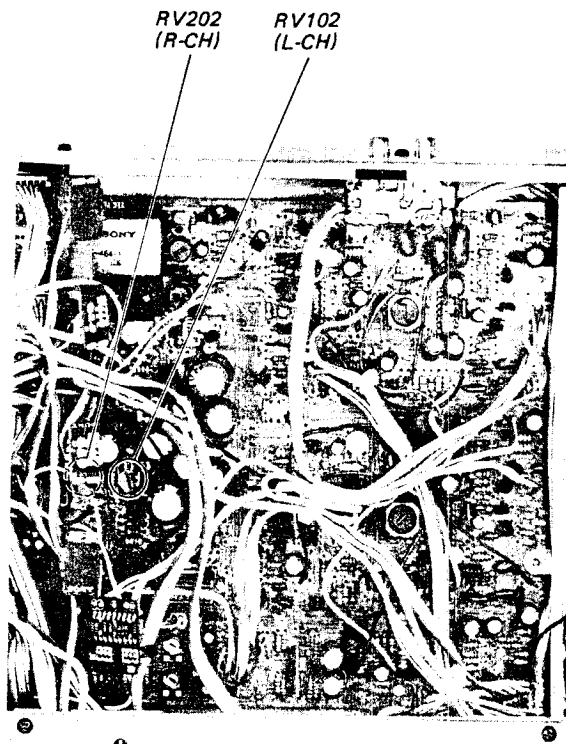

Record Bias Adjustment

Setting:

REC LEVEL control: standard record
(See page 24)

Procedure:

1. Mode: record

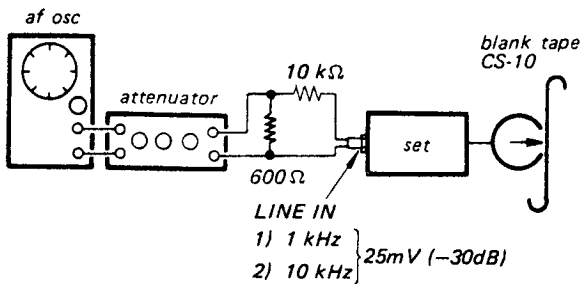

2. Mode: playback

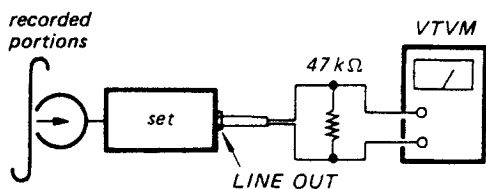

Adjust CT001 (L-CH), (R-CH) so that the LINE OUT level of 10 kHz signal is 0 dB relative to that of 1 kHz.

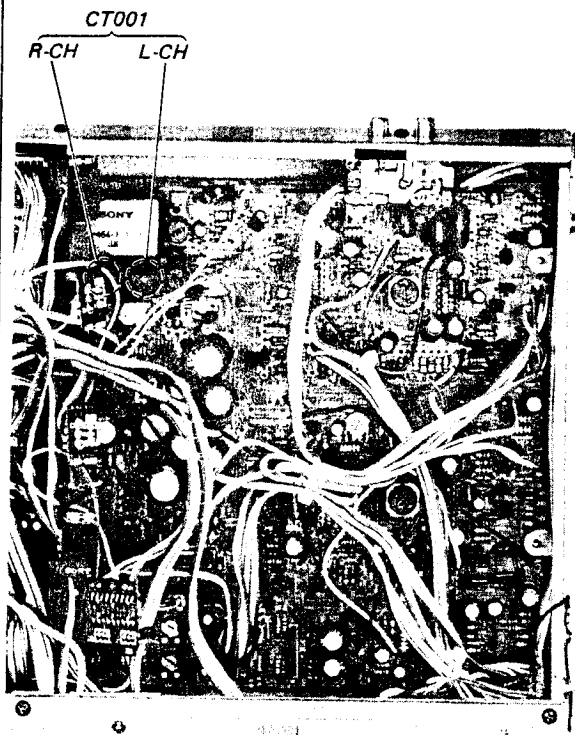

Record Level Adjustment

Setting:

REC LEVEL control: standard record
(See page 24)

Procedure:

1. Mode: record

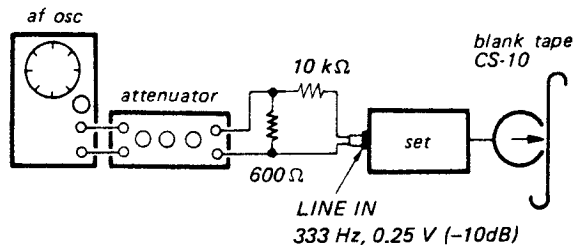

2. Mode: playback

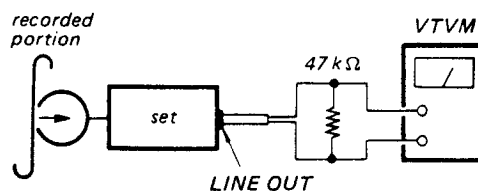

Specification:

LINE OUT level : 0.41 ~ 0.46 V
(-5.5 ~ -4.5 dB)

Adjustment Location:

- record/playback board -

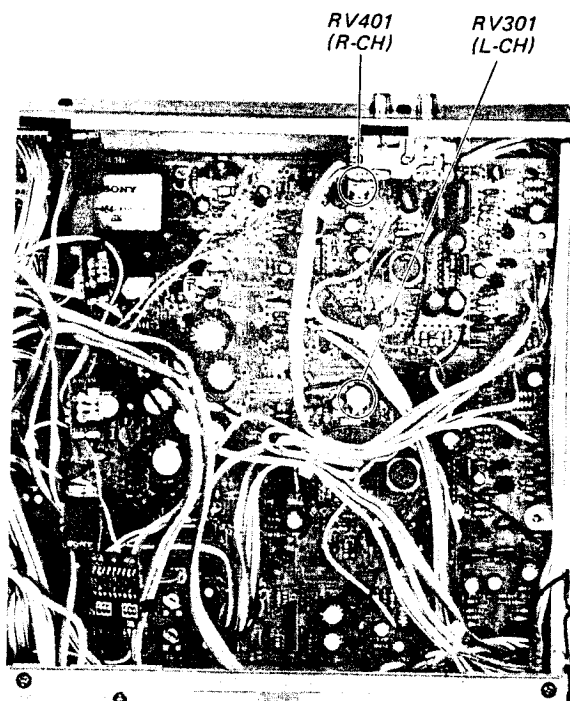

LEVEL METER CALIBRATION

Procedure:

1. Mode : record

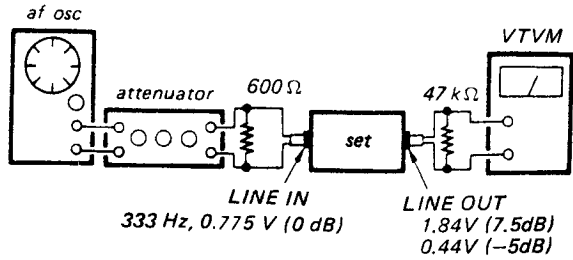

1. Set the REC LEVEL control so that the LINE OUT level is +6.5 dB.
2. Adjust RV103 (L-CH) and RV203 (R-CH) so that the LEDs including 8 dB (right-most element) light up.
3. Set the REC LEVEL control so that the LINE OUT level is -5 dB.
Make sure that LED meter indicates -4 dB (0 VU).

Note: Slide the REC LEVEL control rightward slowly.
(Be careful to peakhold indication.)

Adjustment Location:

- record/playback board -



RV203
(R-CH)

RV103
(L-CH)

For Service Manuals Contact
MAURITRON TECHNICAL SERVICES
 8 Cherry Tree Rd, Chinnor
 Oxon OX9 4QY
 Tel: 01844-351694 Fax: 01844-352554
 Email: enquiries@mauritron.co.uk

TERMINAL NAME, WAVEFORM AND OPERATING VOLTAGES OF IC501

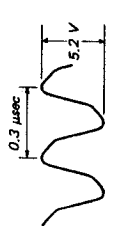
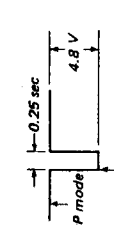
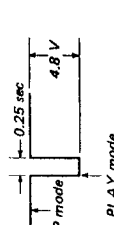
PIN No.	WAVEFORM OR VOLTAGES	PIN No.	WAVEFORM OR VOLTAGES
1	GND (Ground)	16	B/AS 4.8 V
2	Xtal Signal 	17	AMS-Kick Drive Signal 
3	Reset Signal 4.6 V	18	LINE-Muting Drive Signal REC/PLAY mode: 0 V STOP mode: 4.8 V
4	IRQ 5 V	19	REC-Muting Drive Signal REC mode: 0.1 V STOP mode: 1.5 V
5	Not used	20	AMS Muting Drive Signal 0.6 V
6	S1 Signal 4.9 V	21	GND (Ground)
7	SC70 5 V	22	AMS Solenoid Drive Signal REW/FF mode: 0 V STOP mode: 5 V
8	TC 5 V	23	Head-Solenoid Drive Signal PLAY mode: 4.8 V
9	PLAY Lamp Drive Signal PLAY mode: 0.3 V STOP mode: 3.4 V	24	Head-Kick Drive Signal 
10	REC Lamp Drive Signal REC mode: 0.2 V STOP mode: 4.8 V	25	REC/PB Relay Drive Signal REC mode: 0 V STOP mode: 4.8 V
11	PAUSE Lamp Drive Signal PAUSE mode: 0.3 V STOP mode: 3.5 V	26	Timer Signal Timer Switch OFF mode: 4.8 V PLAY mode: 0 V
12	Not used	27	Timer Signal Timer Switch OFF mode: 4.8 V REC mode: 0 V
13	REW-Motor Drive Signal REW mode: 0 V STOP mode: 4.8 V	28	3H/2H 4.8 V
14	PLAY-Motor Drive Signal PLAY mode: 0 V STOP mode: 4.8 V	29	AMS Operating Signal STOP mode: 4.8 V
15	FF-Motor Drive Signal FF mode: 0 V STOP mode: 4.8 V	30	AMS Mode Signal ON mode: 0.05 V OFF mode: 4.8 V
16	Accidental Erasure With cassette: 4.8 V Without cassette: 0 V	31	STOP button kept pressed

Note: Voltage readings on this list are measured by oscilloscope with 10 MΩ probe. Therefore the readings are a little different from those measured by VOM on the schematic and mounting diagrams.

TERMINAL NAME, WAVEFORM AND OPERATING VOLTAGES OF IC502

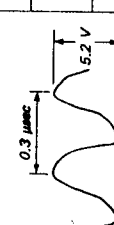
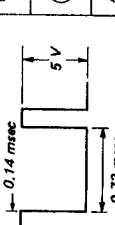
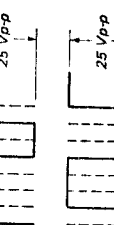
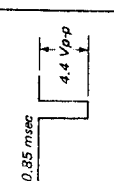
PIN No.	WAVEFORM OR VOLTAGES	PIN No.	WAVEFORM OR VOLTAGES
1	GND (Ground)	5	S0 4.9 V
2	Xtal Signal 	6	S1 5 V
3	Reset Signal	7	SC70 5 V
4	IRQ Signal 	8	TC 5 V
5	Drive Signal for "a" Segment of Fluorescent Display Tube 1) In case of all six "a" segments are lit, i.e., all of the six digits are "1", "0", "4", "8" or "9", without the AMS and REPEAT. 2) In case of one of "a" segments is lit, i.e., one out of six digits are "1", "0", "4", "8", "9", "5", "6", "7", "3", "2", "0", "9", and all others are "1" or "4". 3) In case of two "a" segments out of six digits are lit as in the case of 2) above. 4) In case of three "a" segments out of six digits are lit as in the case of 2) above. 5) In case of all "a" segments are lit in the same way.	9	Not used
6	AMS Solenoid Drive Signal REW/FF mode: 0 V STOP mode: 5 V	10	Not used
7	Head-Solenoid Drive Signal PLAY mode: 4.8 V	11	Not used
8	Head-Kick Drive Signal 	12	Not used (counter)
9	REC/PB Relay Drive Signal REC mode: 0 V STOP mode: 4.8 V	13	AMS Signal 0 V
10	Timer Signal Timer Switch OFF mode: 4.8 V PLAY mode: 0 V	14	Drive Signal for "i" Segments of Fluorescent Display Tube same as terminal 13 for segments "i".
11	Timer Signal Timer Switch OFF mode: 4.8 V REC mode: 0 V	15	Drive Signal for "j" Segments of Fluorescent Display Tube same as terminal 13 for segments "j".
12	3H/2H 4.8 V	16	Drive Signal for "k" Segments of Fluorescent Display Tube same as terminal 13 for segments "k".
13	AMS Operating Signal STOP mode: 4.8 V	17	Drive Signal for "l" Segments of Fluorescent Display Tube same as terminal 13 for segments "l".
14	AMS Mode Signal ON mode: 0.05 V OFF mode: 4.8 V	18	Drive Signal for "m" Segments of Fluorescent Display Tube same as terminal 13 for segments "m".
15	STOP button kept pressed	19	Drive Signal for "n" Segments of Fluorescent Display Tube same as terminal 13 for segments "n".
16	ACCIDENTAL ERASURE With cassette: 4.8 V Without cassette: 0 V	20	Drive Signal for "Op" (dot) of Fluorescent Display Tube Left Side Dot (lit up constantly) Right Side Dot (Blinking Memory Dot)
17	STOP button kept pressed	21	Drive Signal for "p" Segments of Fluorescent Display Tube same as terminal 13 for segments "p".
18	STOP button kept pressed	22	Drive Signal for "q" Segments of Fluorescent Display Tube same as terminal 13 for segments "q".
19	STOP button kept pressed	23	Drive Signal for "r" Segments of Fluorescent Display Tube same as terminal 13 for segments "r".
20	STOP button kept pressed	24	Drive Signal for "s" Segments of Fluorescent Display Tube same as terminal 13 for segments "s".
21	STOP button kept pressed	25	Drive Signal for "t" Segments of Fluorescent Display Tube same as terminal 13 for segments "t".
22	STOP button kept pressed	26	Drive Signal for "u" Segments of Fluorescent Display Tube same as terminal 13 for segments "u".
23	STOP button kept pressed	27	Drive Signal for "v" Segments of Fluorescent Display Tube same as terminal 13 for segments "v".
24	STOP button kept pressed	28	Drive Signal for "w" Segments of Fluorescent Display Tube same as terminal 13 for segments "w".
25	STOP button kept pressed	29	Drive Signal for "x" Segments of Fluorescent Display Tube same as terminal 13 for segments "x".
26	STOP button kept pressed	30	Drive Signal for "y" Segments of Fluorescent Display Tube same as terminal 13 for segments "y".
27	STOP button kept pressed	31	Drive Signal for "z" Segments of Fluorescent Display Tube same as terminal 13 for segments "z".
28	STOP button kept pressed	32	AMS Signal 0 V
29	STOP button kept pressed	33	Switch 1 Signal Following waveform appears while AMS, REPEAT, MEMORY, CLEAR, or COUNTER switch is kept pressed. 
30	STOP button kept pressed	34	AMS Signal Output 4.8 V
31	STOP button kept pressed	35	AMS MODE 4.8 V
32	STOP button kept pressed	36	Not used
33	STOP button kept pressed	37	REC Lamp Input REC mode: 0.2 V STOP mode: 4.8 V
34	STOP button kept pressed	38	PAUSE Lamp Input 4.8 V
35	STOP button kept pressed	39	FF-Motor Input FF mode: 0 V STOP mode: 4.8 V
36	STOP button kept pressed	40	PLAY-Motor Input PLAY mode: 0 V STOP mode: 4.8 V
37	STOP button kept pressed	41	REW-Motor Input REW mode: 0 V STOP mode: 4.8 V
38	STOP button kept pressed	42	B + Supply Voltage DC 5 V

4-1. MOUNTING DIAGRAM - Audio Section - SECTION 4

- Conductor Side -

A

B

DIAGRAMS

C

D

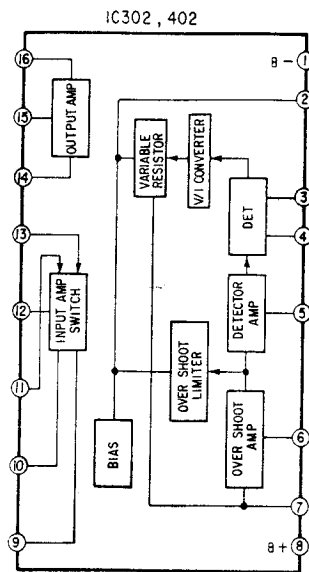
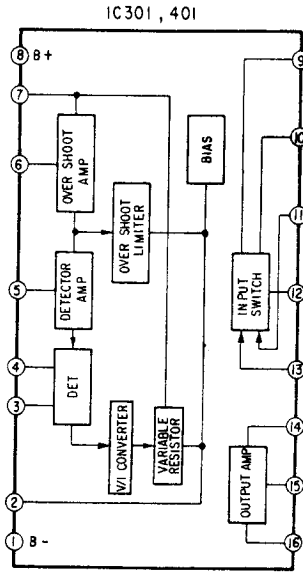

[PIN JACK BOARD]

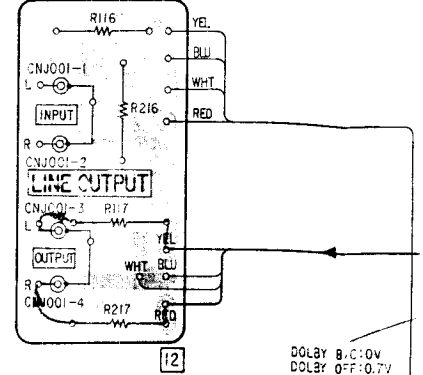

DOLBY B/C:0V
DOLBY OFF:0.7V

0
DOLBY :0.7V

[DOLBY SWITCH BOARD]

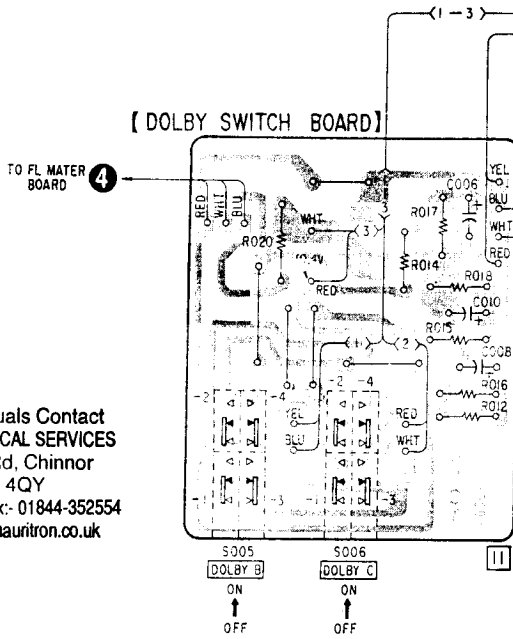

DOLBY OFF:0.7V
DOLBY C:0.6V

JV
DOLBY B:0.7V

JV
DOLBY B:0.7V

DOLBY B/C:0V
DOLBY OFF:0.7V

0V
DOLBY B:0.7V

[RECORD EQ BOARD]

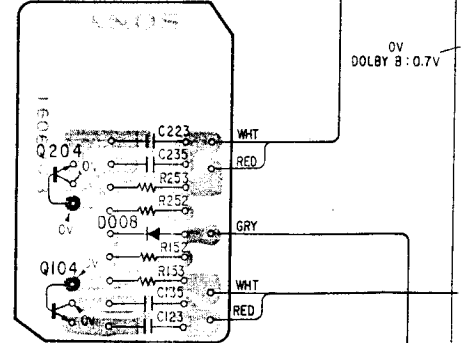

For Service Manuals Contact
MAURITRON TECHNICAL SERVICES
8 Cherry Tree Rd, Chinnor
Oxon OX9 4QY
Tel: 01844-351694 Fax: 01844-352554
Email: enquiries@mauritron.co.uk

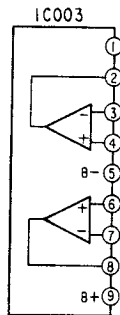
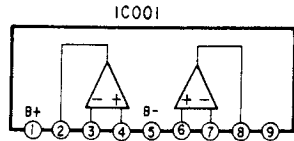

[REC VR BOARD]

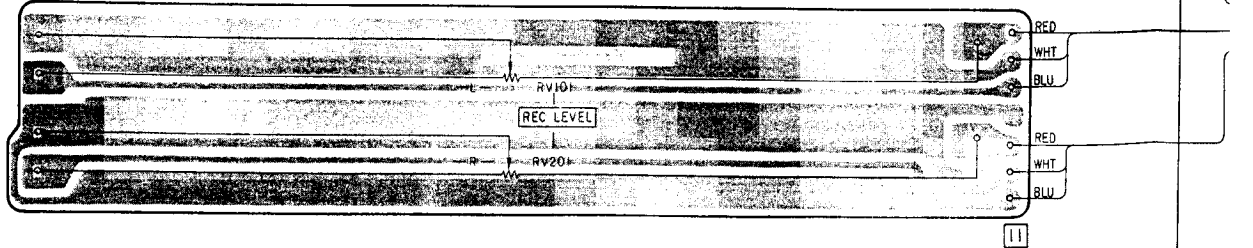

IC302, 402

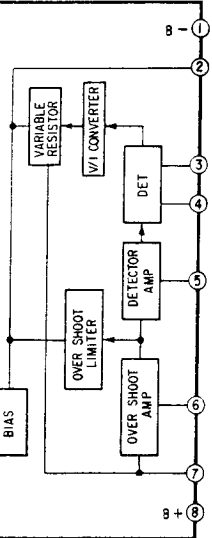

[PIN JACK BOARD]

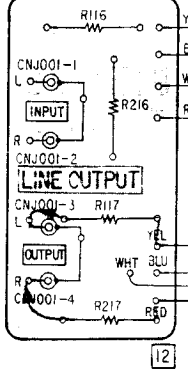

[RECORD/PLAYBACK BOARD]

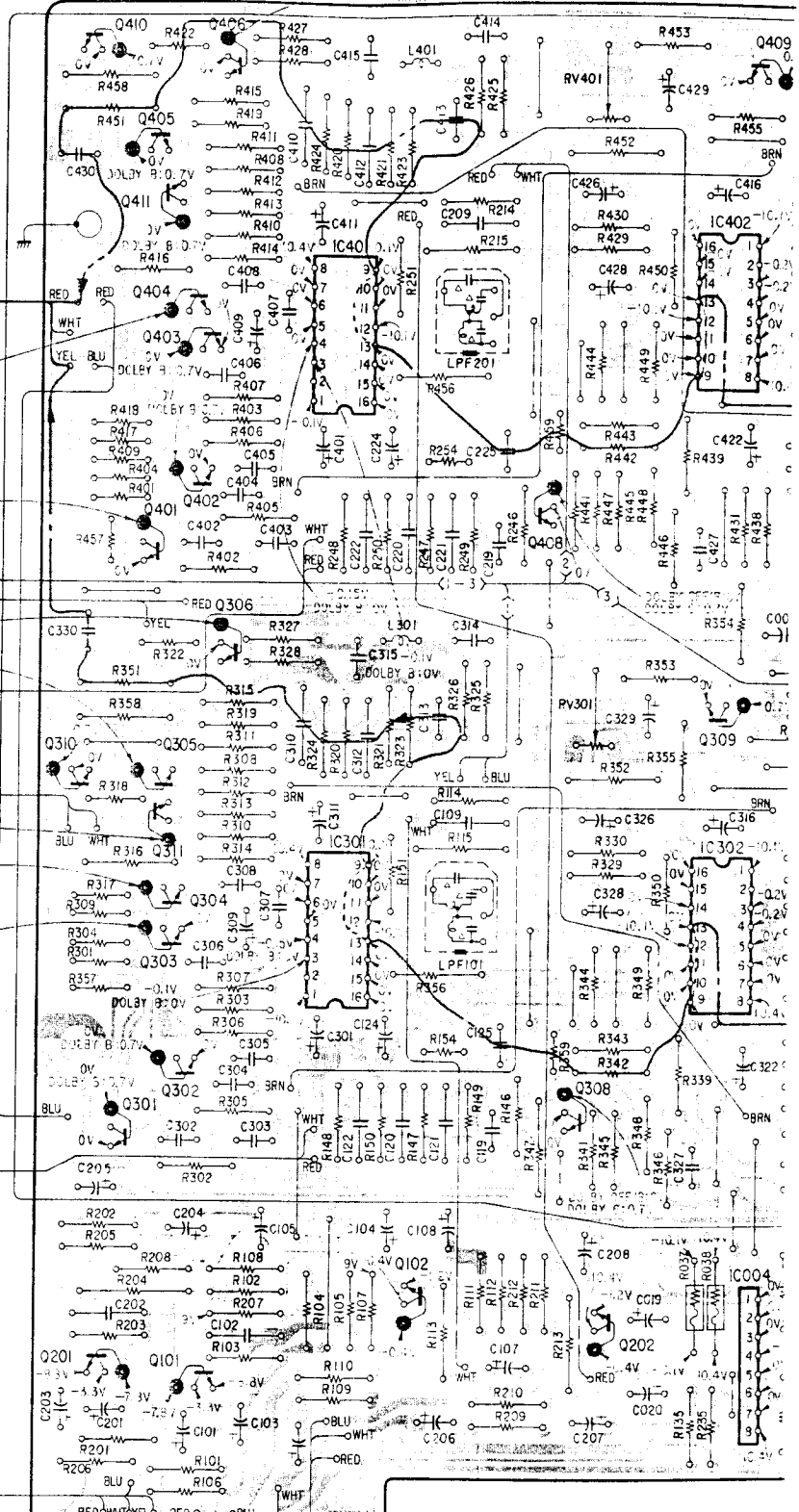

[RECORD EQ BOARD]

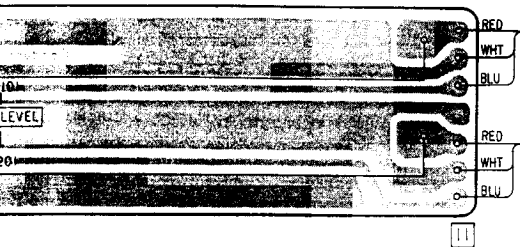
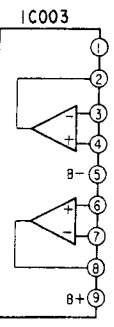
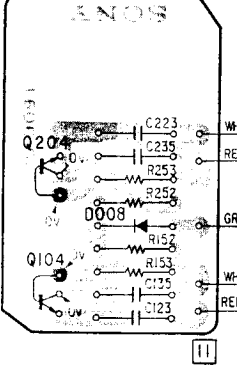

[HEADPHONE VR BOARD]

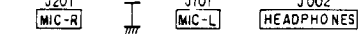
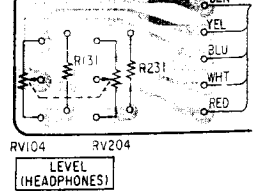

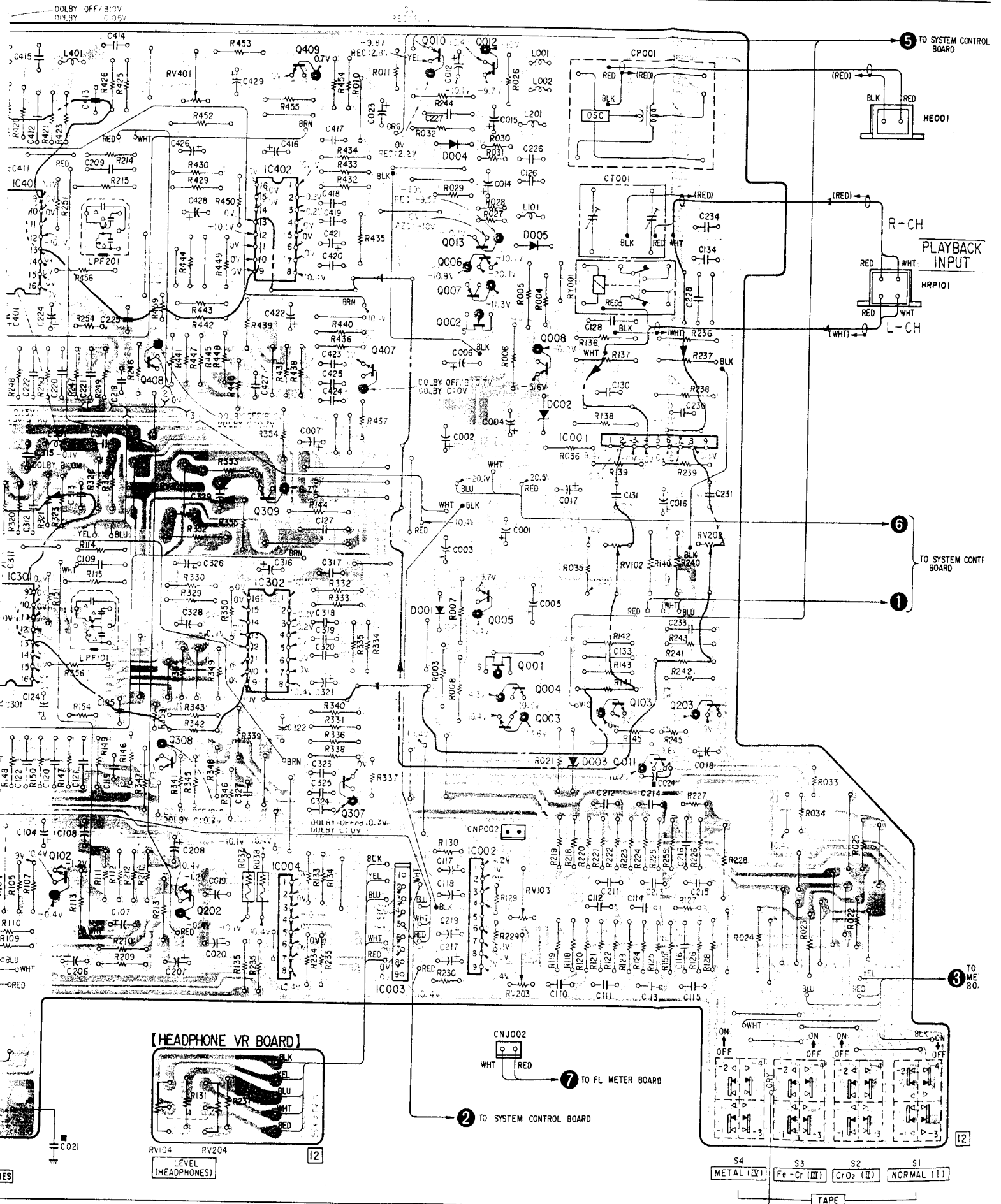

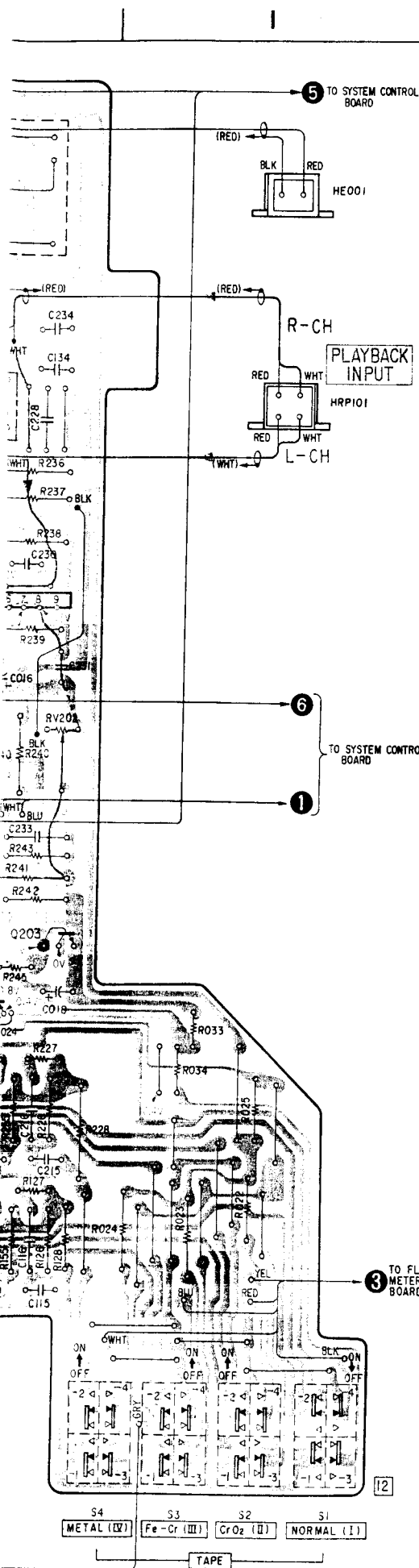

IC - Q	D
410 409 012	
406 010	
405	
411	004
IC402	
IC401	
404	
403 013	005
006	
007	
002	
408 008	
402 407	
401	002
306	
IC001	
309	
310	
305	
311	
IC302	
IC301	001
304	
303	001
004	
103	
203	
003	
302	
204	
301 308 011	003
008	
307	
104	
102 IC002	
IC004	
202	
IC003	
201	
101	

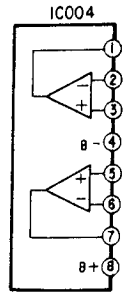
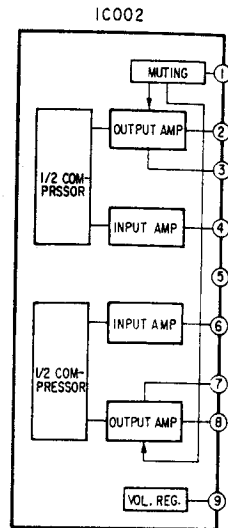

For Service Manuals Contact
MAURITRON TECHNICAL SERVICES
 8 Cherry Tree Rd, Chinnor
 Oxon OX9 4QY
 Tel: 01844-351694 Fax: 01844-352554
 Email: enquires@mauritron.co.uk

Note:

- Color code of sleeving over the end of the jacket.

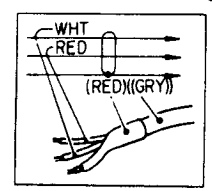

- ○ : parts extracted from the component side.
- ● : parts extracted from the conductor side.
- B + pattern
- B - pattern
- → : signal path
- → : L-CH signal path
- → : R-CH signal path
- See page 45 for Semiconductor Lead Layouts.

4.2. SCHEMATIC DIAGRAM

- Audio Section -

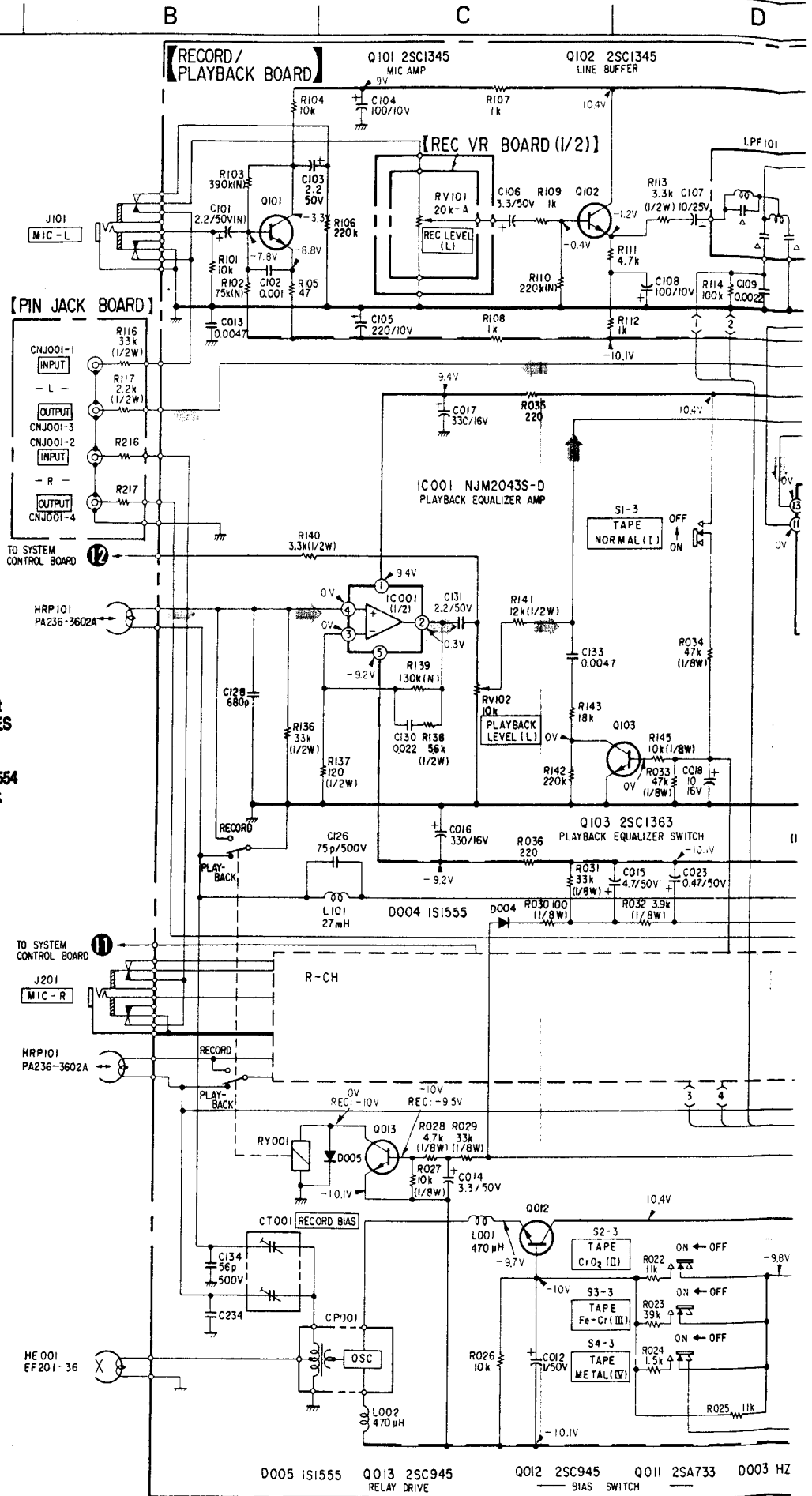

For Service Manuals Contact
MAURITRON TECHNICAL SERVICES
 8 Cherry Tree Rd, Chinnor
 Oxon OX9 4QY
 Tel:- 01844-351694 Fax:- 01844-352554
 Email:- enquiries@maurtron.co.uk

C

D

E

F

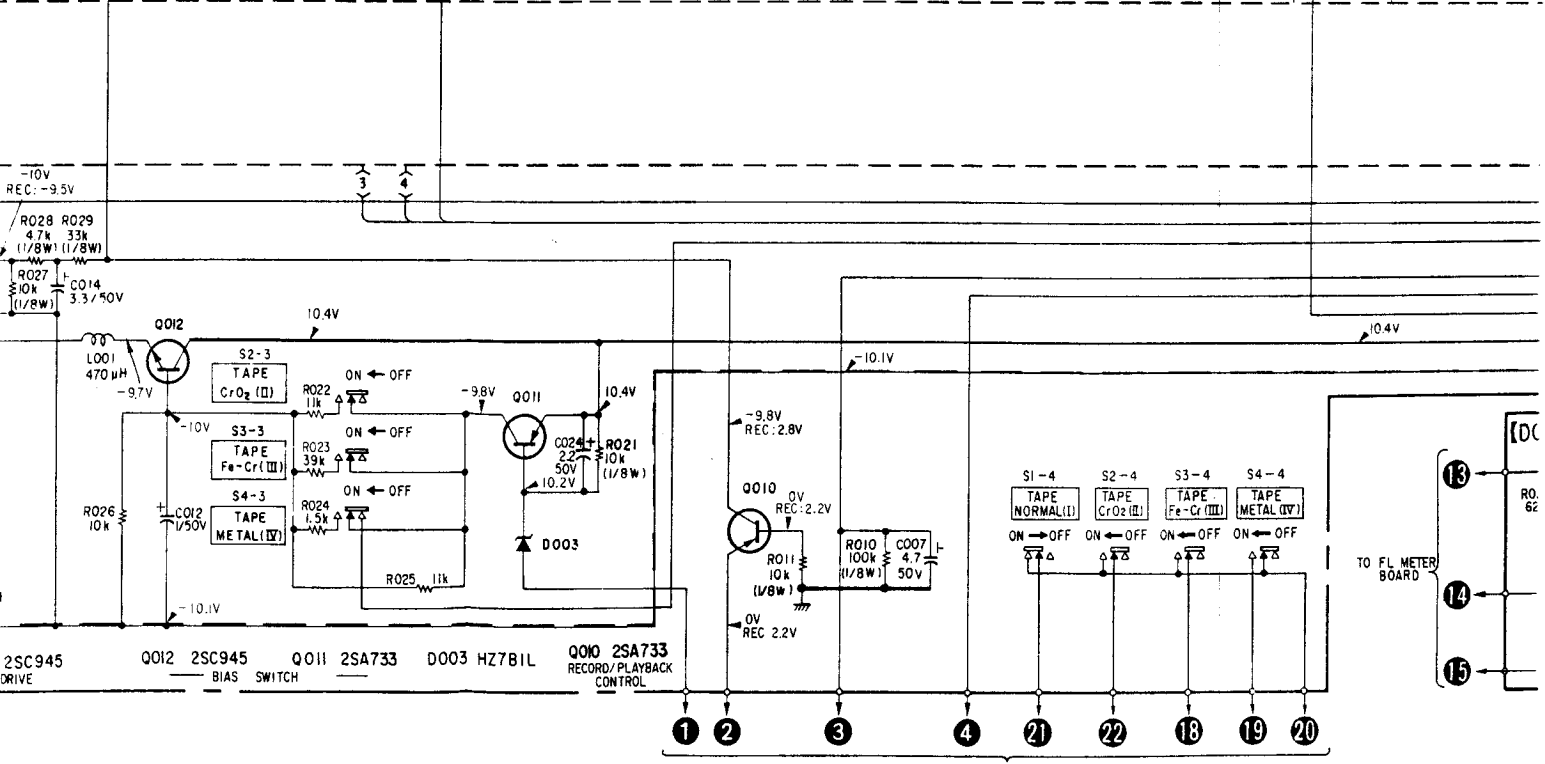
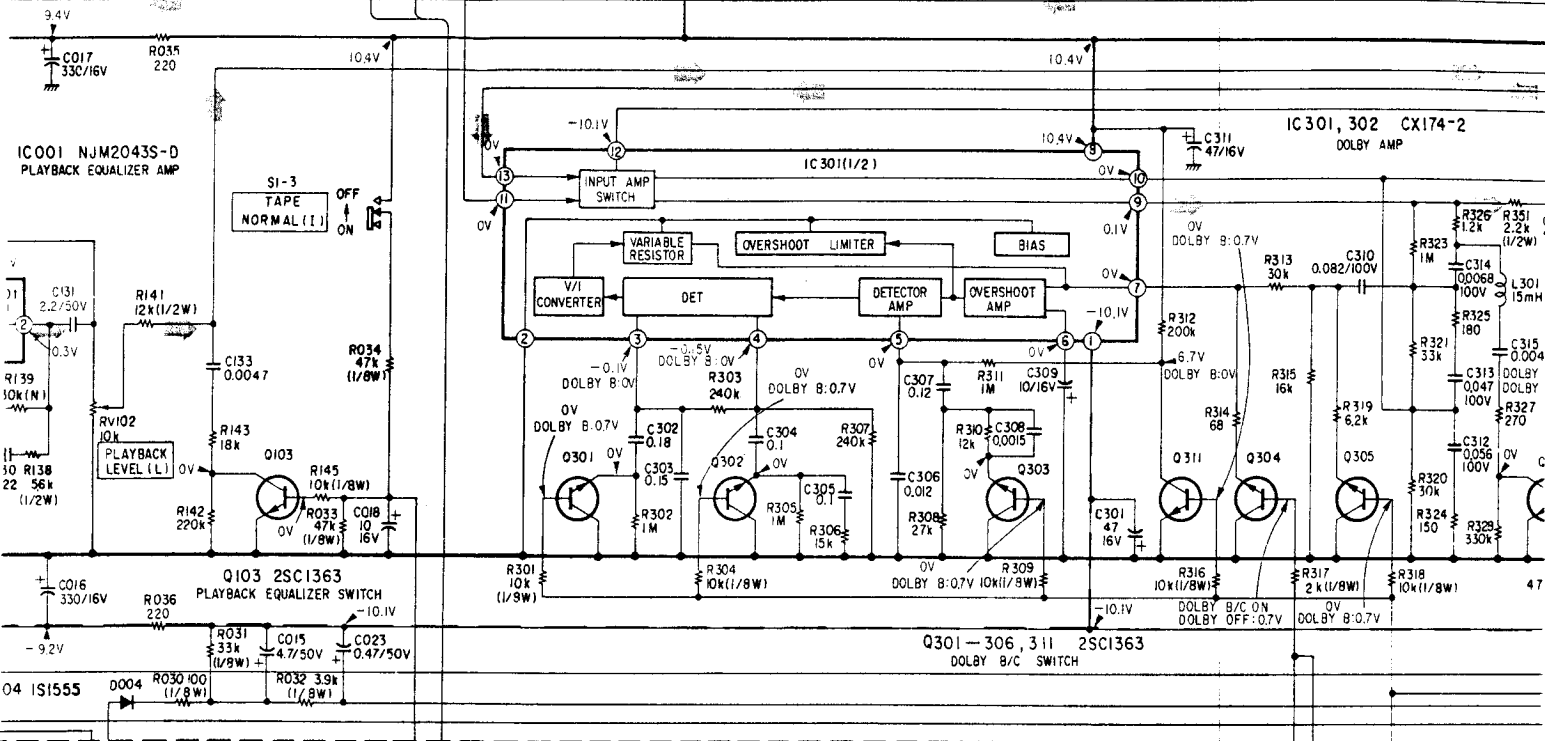
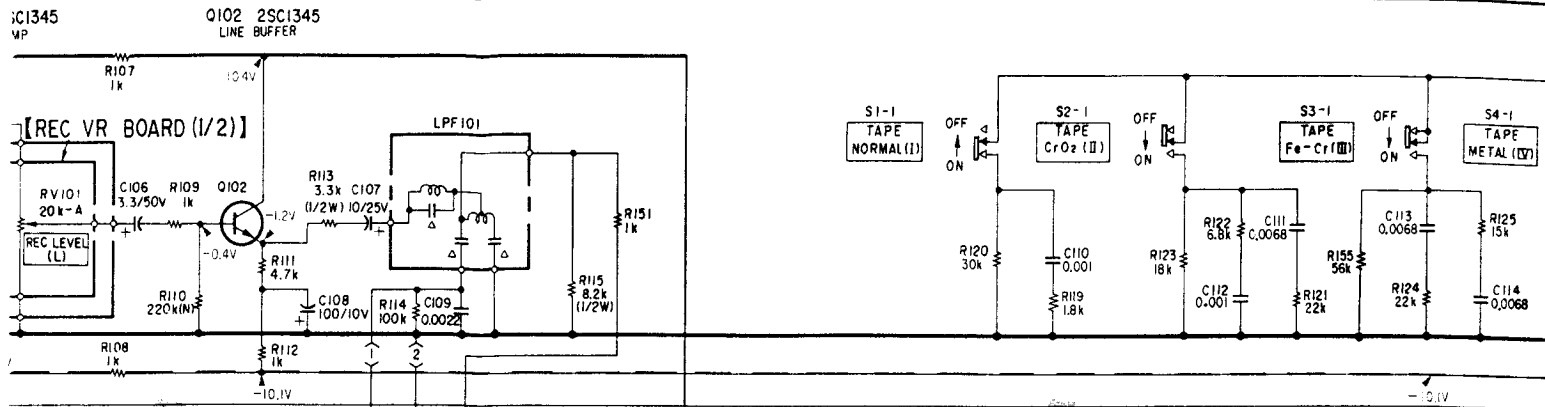

[RECORD

D008 ISI555

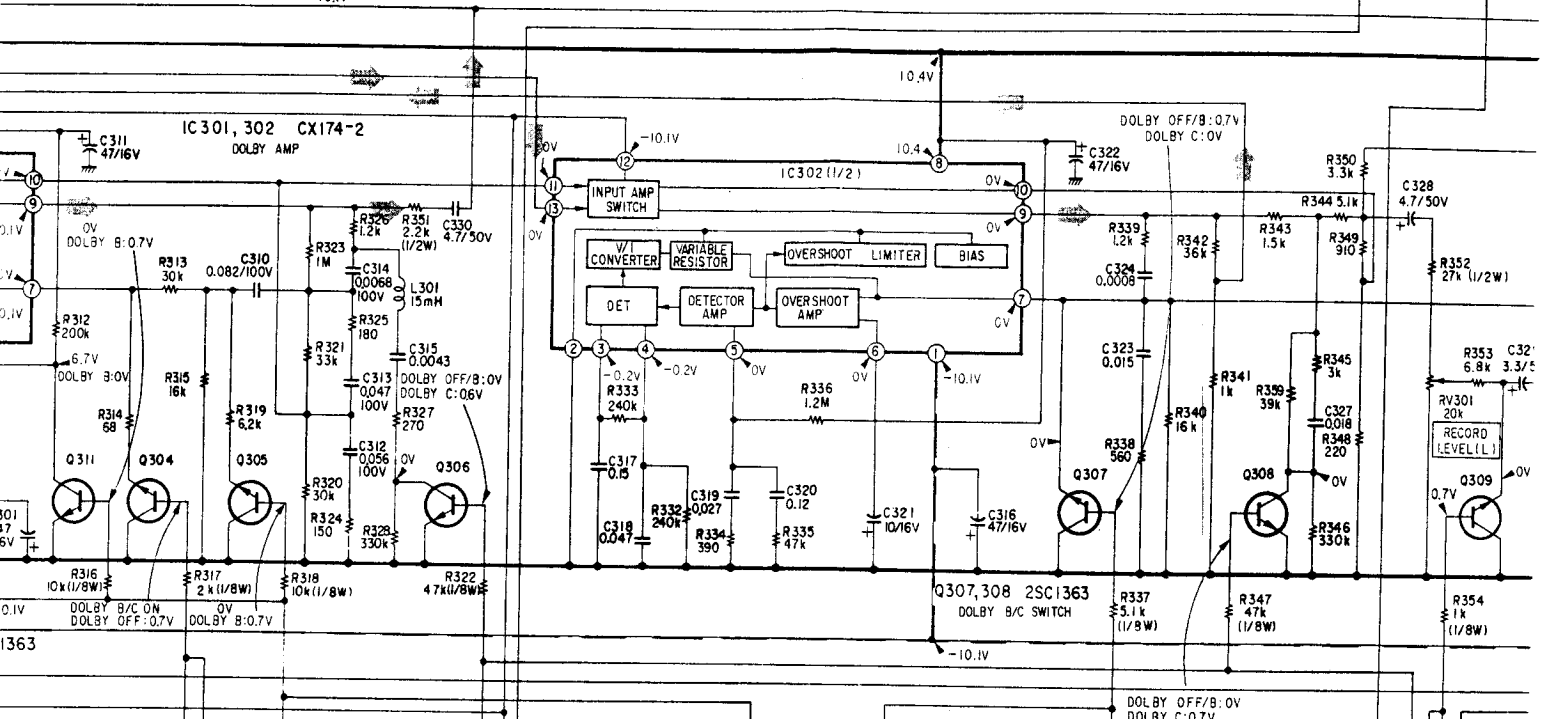
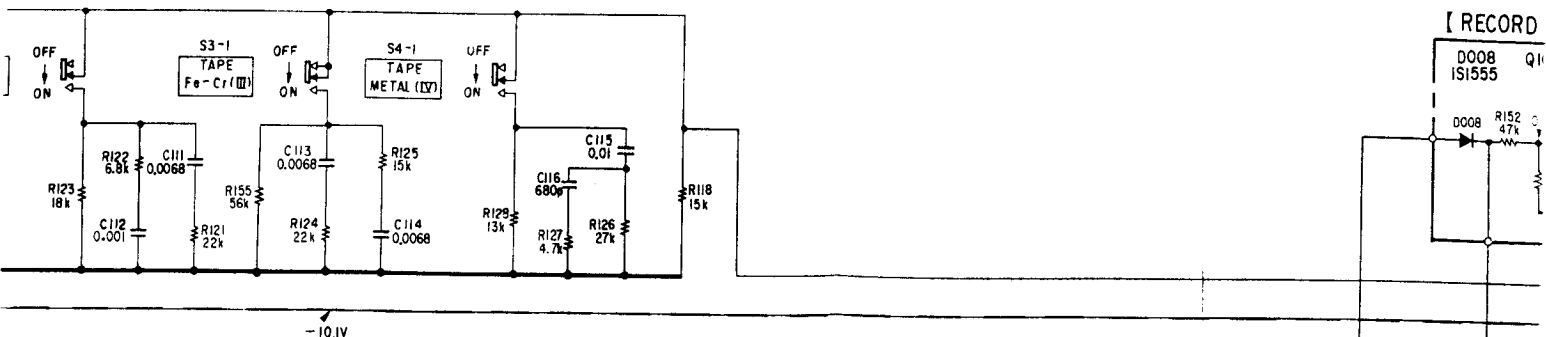
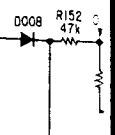

For Service Manuals Contact
MAURITRON TECHNICAL SERVICES
 8 Cherry Tree Rd, Chinnor
 Oxon OX9 4QY
 Tel: 01844-351694 Fax: 01844-352554
 Email: enquires@mauritron.co.uk

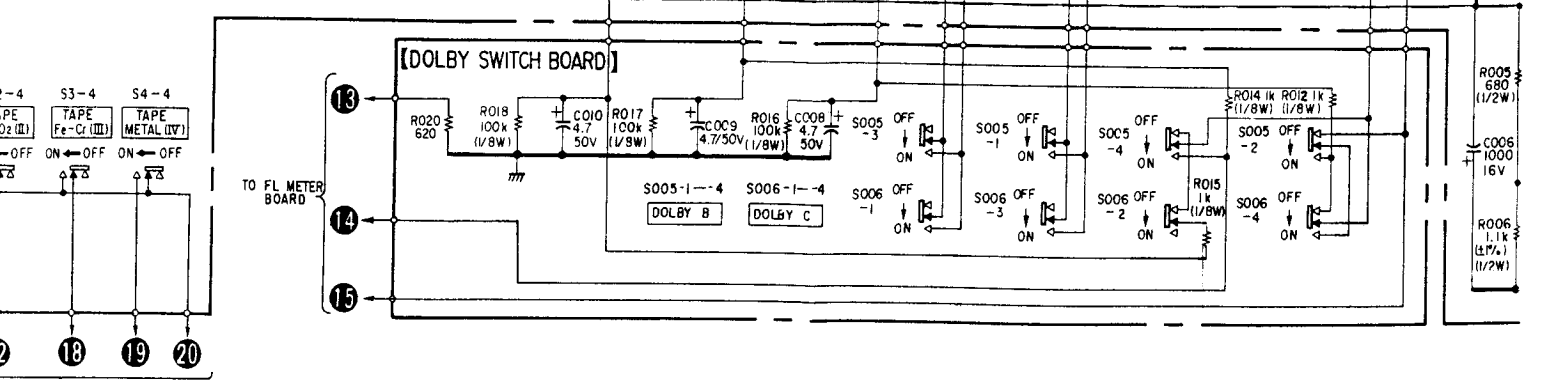
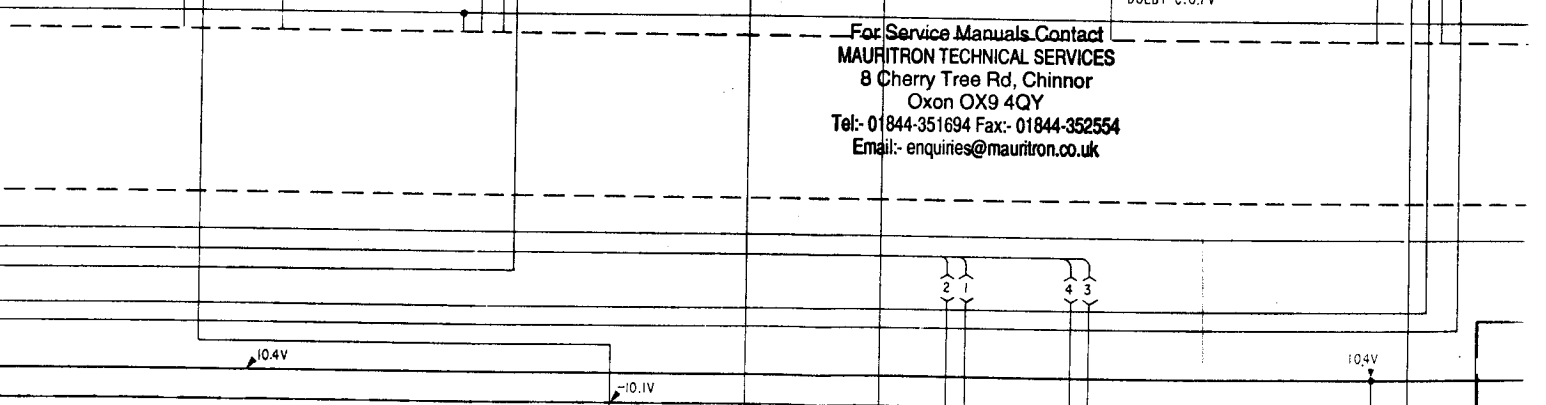

[RECORD EQ BOARD]

IC002 BA6138
LOG AMP

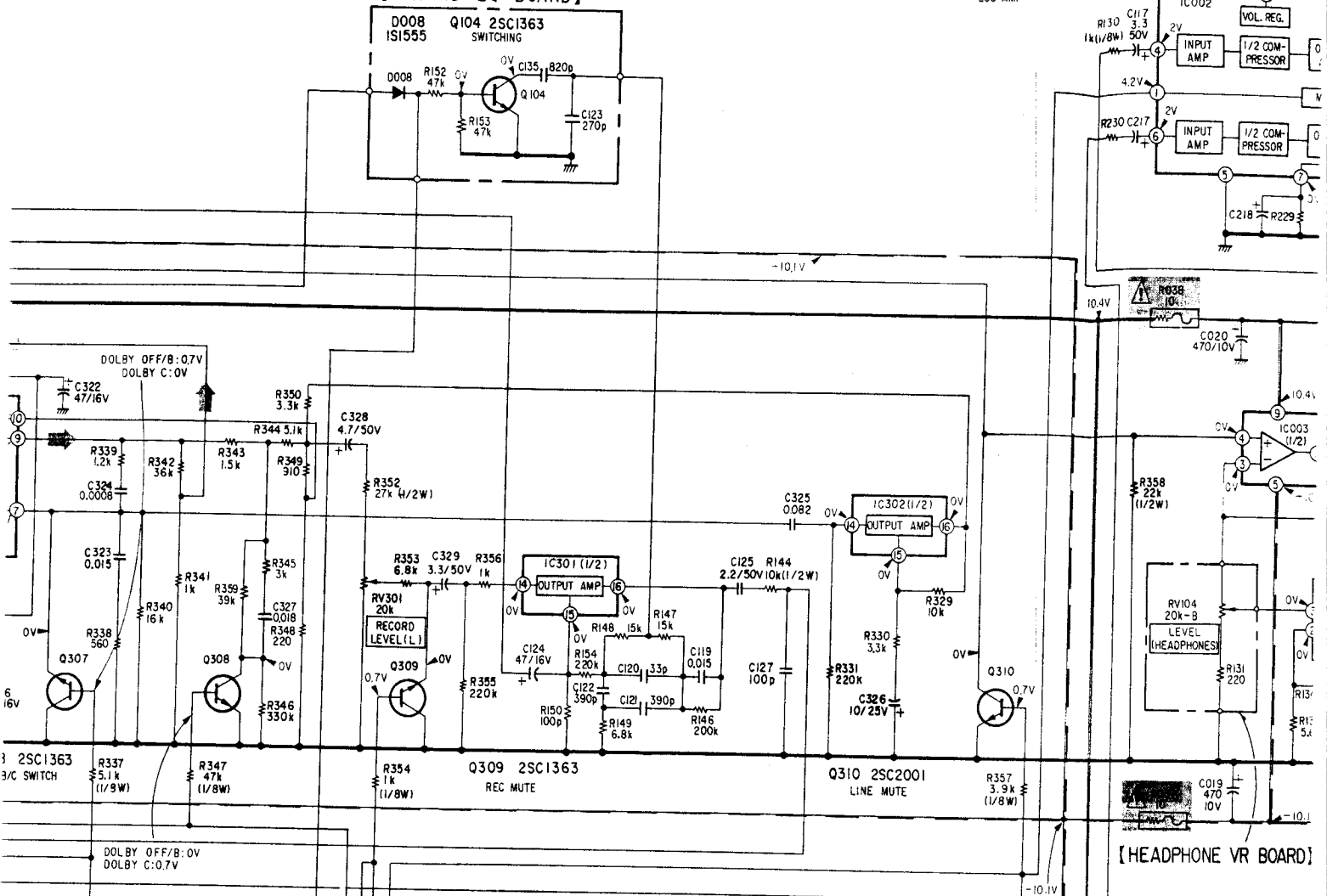

Q003 2SD414 Q006 2SB548
Q004,005 2SD1152 Q007,008 2SB864
D001,002 HZ6B1L
STABILIZER

Q001,002 2SK120
CURRENT REG

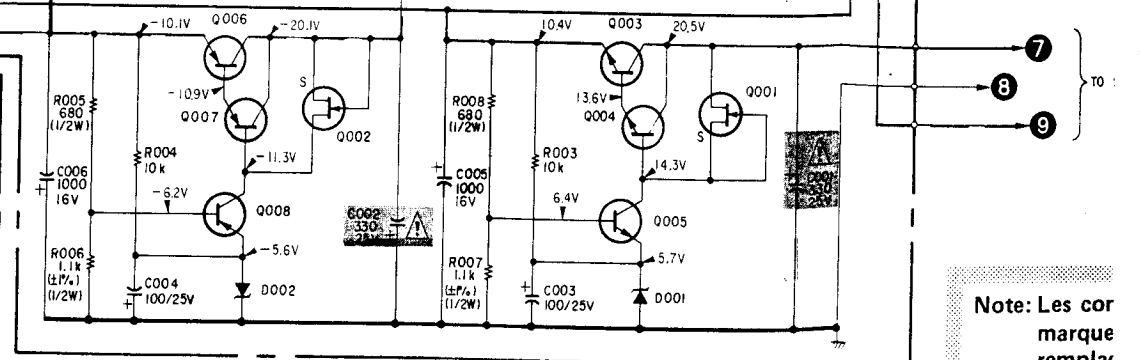

Note: Les composants
remplacés
spécifiés

2 BA6138
G AMP

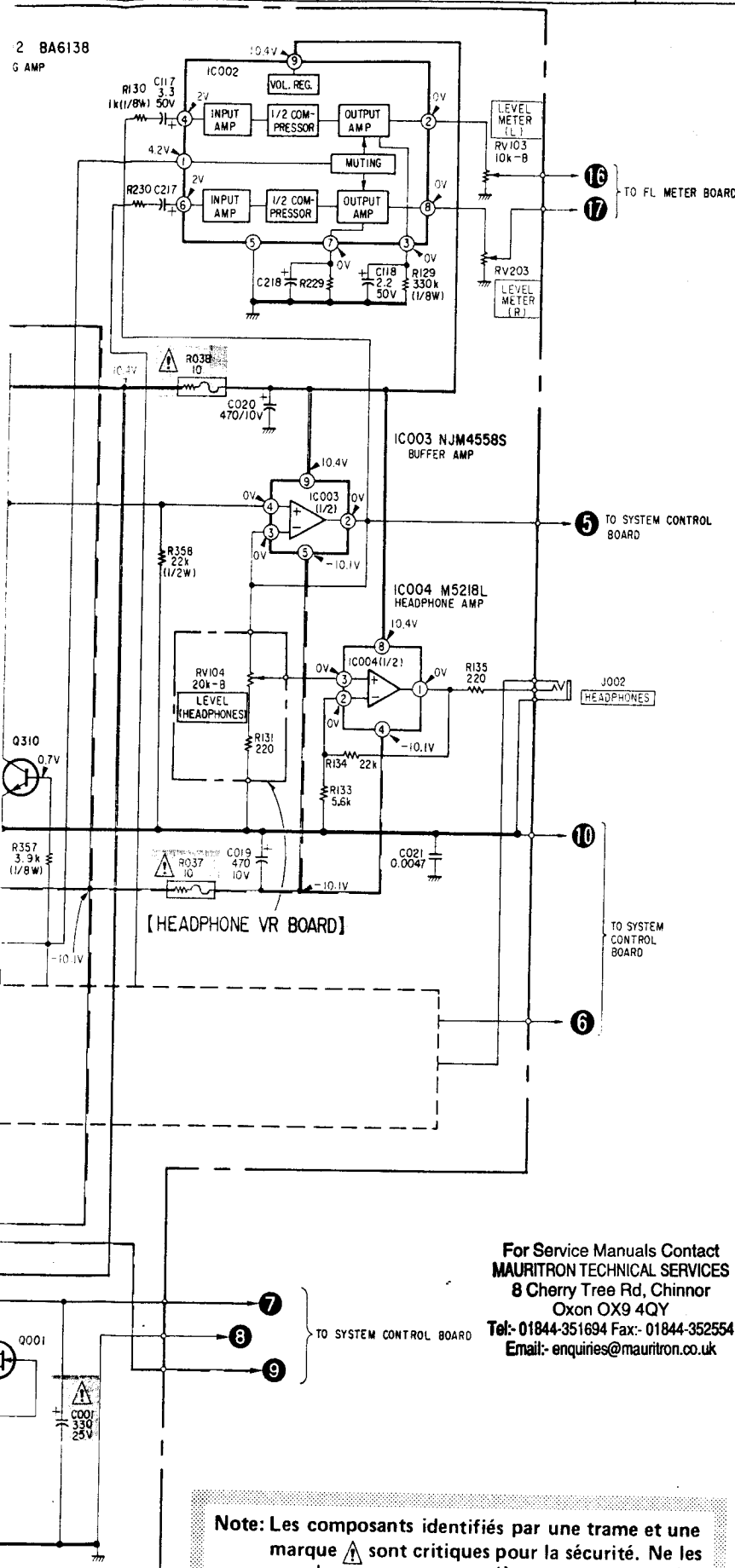

1

2

3

For Service Manuals Contact
MAURITRON TECHNICAL SERVICES
 8 Cherry Tree Rd, Chinnor
 Oxon OX9 4QY
 Tel:- 01844-351694 Fax:- 01844-352554
 Email:- enquiries@mauritron.co.uk

Note:

- Components for right channel have same values as for left channel. Reference numbers are coded from 200 and 400.
- All capacitors are in μF unless otherwise noted. $\text{pF} : \mu\text{F}$ 50WV or less are not indicated except for electrolytics and tantalums.
- All resistors are in ohms, $\frac{1}{4}\text{W}$ unless otherwise noted. $\text{k}\Omega : 1000\Omega$, $\text{M}\Omega : 1000\text{k}\Omega$
- : fusible resistor.
- : panel designation.
- : adjustment for repair.
- : B+ bus.
- : B- bus.
- Readings are taken under no-signal conditions with a VOM (50 $\text{k}\Omega/\text{V}$).
- : signal path.
- Switch

Ref. No.	Switch	Position
S1	TYPE I (NORMAL)	ON
S2	TYPE II (CrO_2)	OFF
S3	TYPE III (Fe-Cr)	OFF
S4	TYPE IV (METAL)	OFF
S005	DOLBY B	OFF
S006	DOLBY C	OFF

Note: Les composants identifiés par une trame et une marque sont critiques pour la sécurité. Ne les remplacer que par une pièce portant le numéro spécifié.

Note: The components identified by shading and mark are critical for safety. Replace only with part number specified.

C D E F

Q	IC	IC50
	D	512,511, 50

• Refer to pages 28 and 29 for voltages and waveforms at terminals of IC501 and 502.

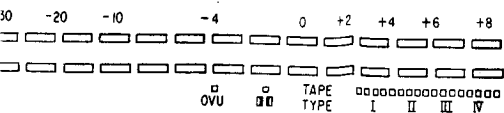

3 34 35 36 37 38 39 40 41 42 43 44 45 46 47 48 49 50 51 52

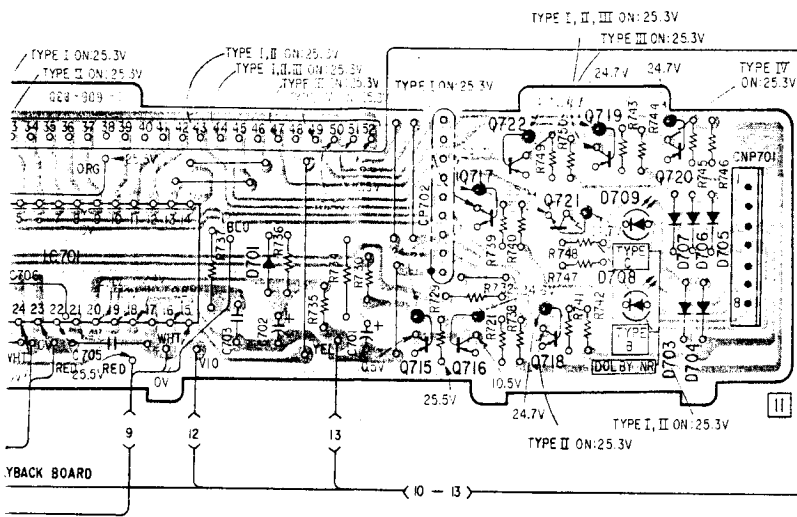

	722	719	720
	717	721	
	715	716	718
701			709 707 706 705
			708 703 704

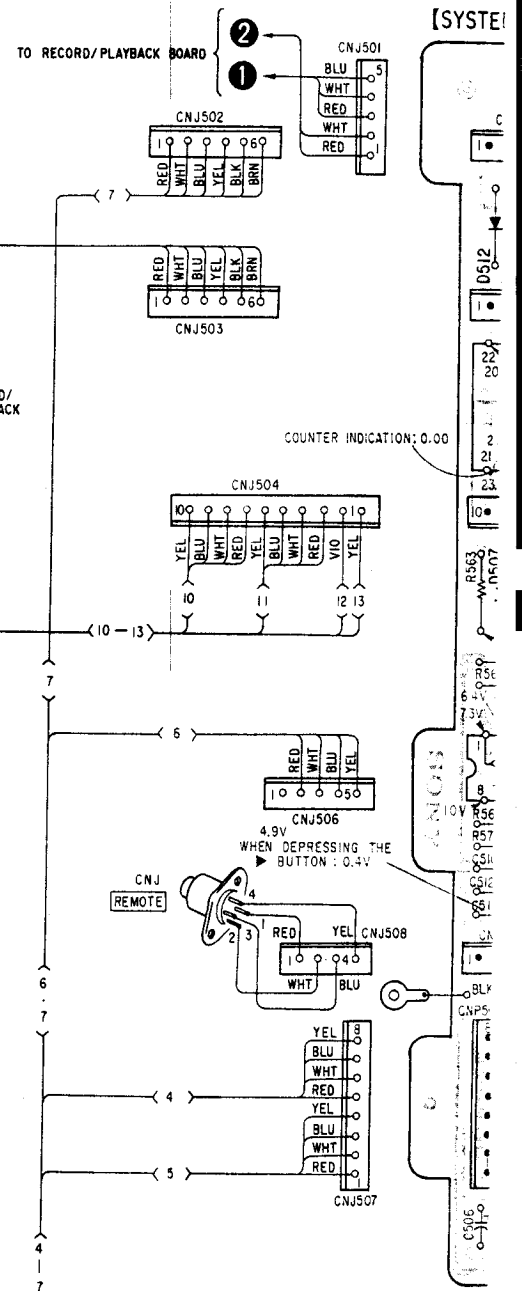
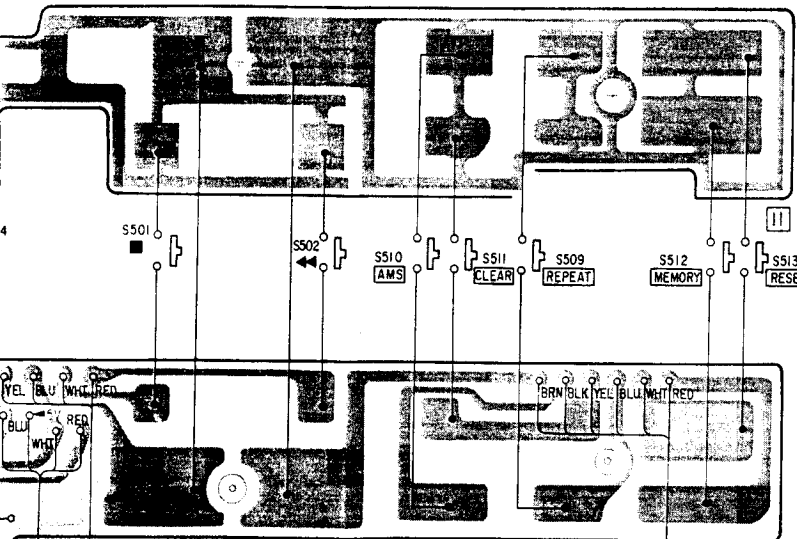

< 4 - 6 > < 4 - 7 >

F

29 for voltages and waveforms
d 502.

Q				601	602	603			604				
IC	IC506	IC505	IC501	508	IC504	507	IC507	513 IC503	509 502	512 501	511 506	510 504	902
D	512,511,508,510,509	507	506		501			601		502			908 90
											513	514, 515, 951,952,953,954	

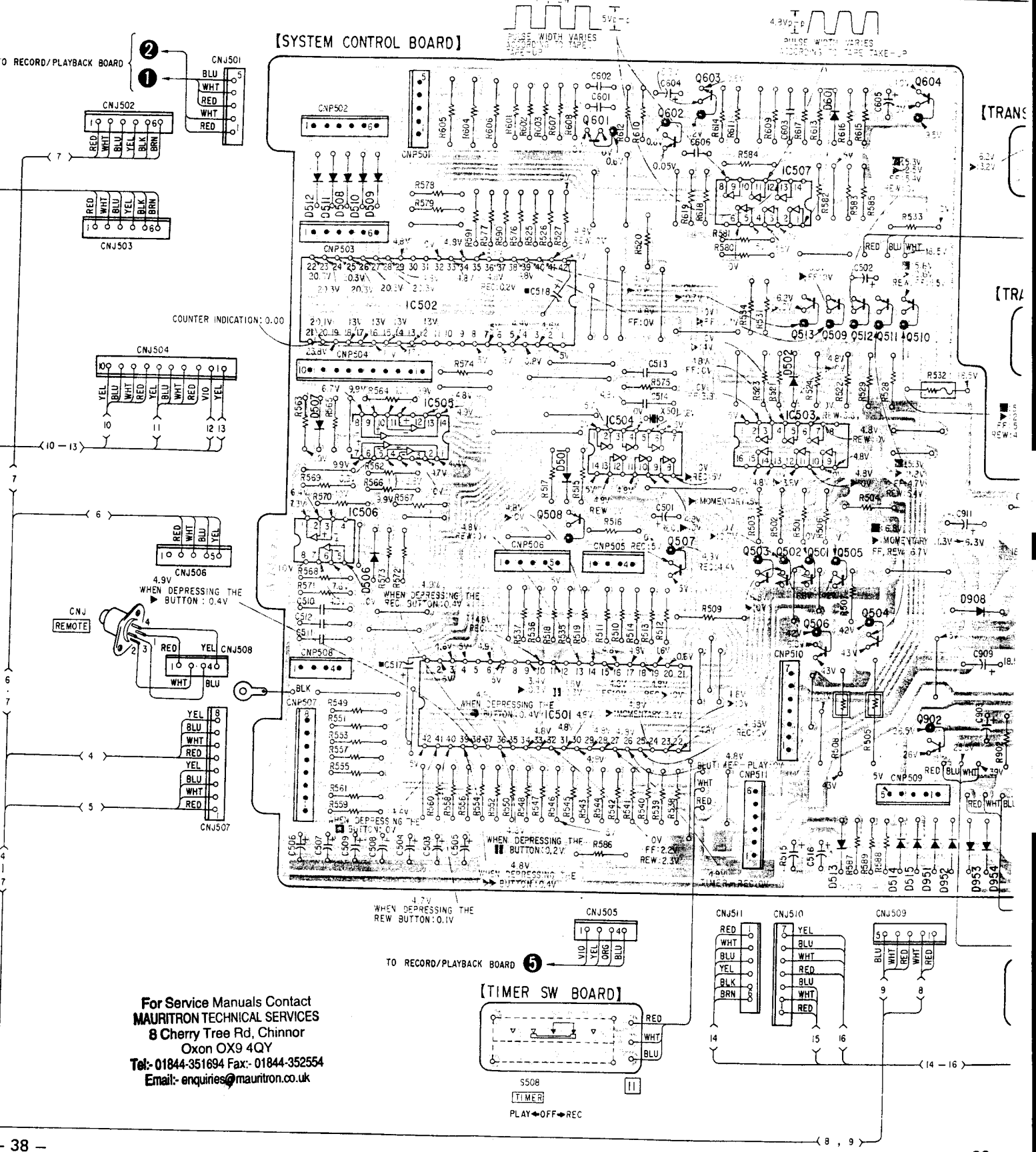

For Service Manuals Contact
MAURITRON TECHNICAL SERVICES
 8 Cherry Tree Rd, Chinnor
 Oxon OX9 4QY
 Tel:- 01844-351694 Fax:- 01844-352554
 Email:- enquiries@mauritron.co.uk

603	604	903
IC507	513 509 512 511 510	907
07	IC503	905
	503 502 501	
	506 505 504	
601	907	
502	908 906	904
		902
		901
		903
	513 514, 515, 951, 952, 953, 954	909, 905

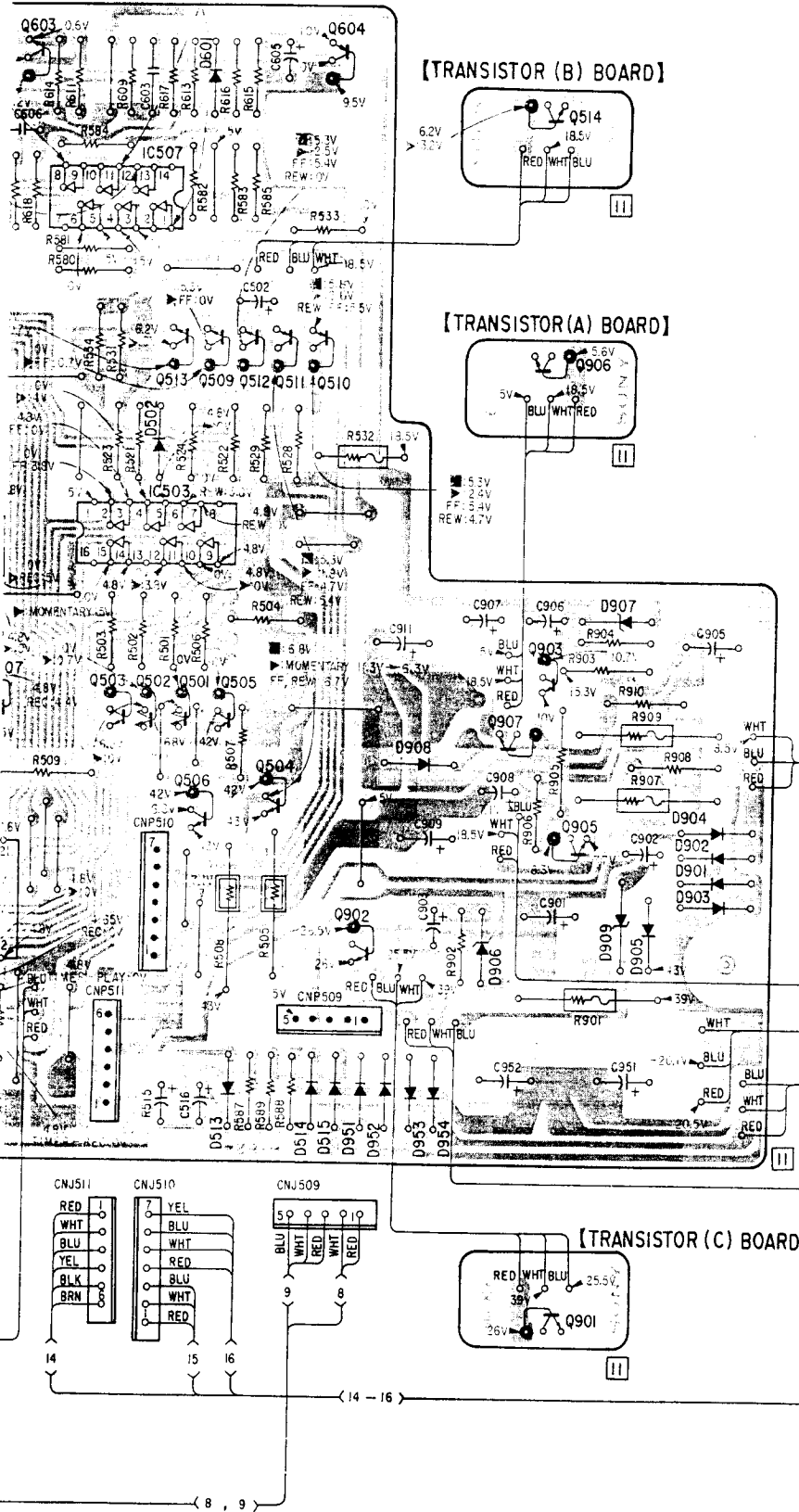
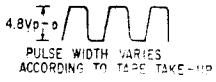

[PHOTO BOARD]

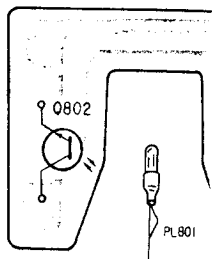

[CASSETTE BOARD]

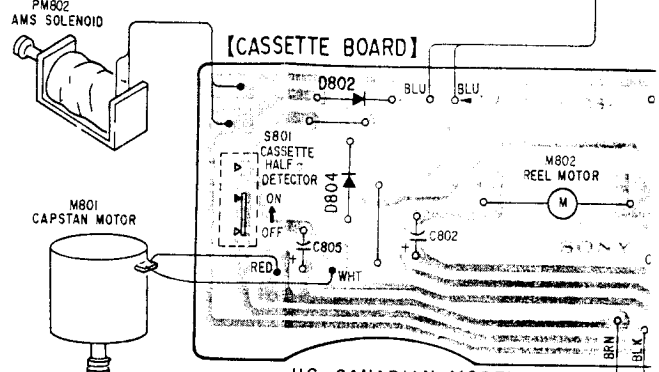

US. CANADIAN MODEL

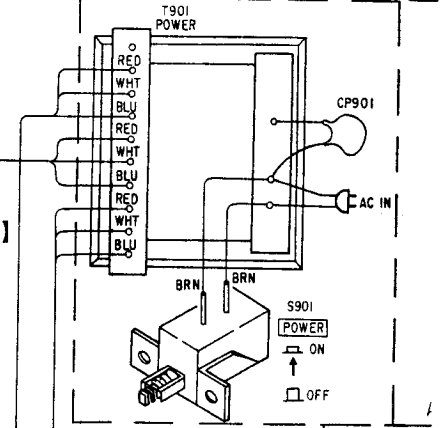

For Service Manuals Contact
MAURITRON TECHNICAL SERVICES
8 Cherry Tree Rd, Chinnor
Oxon OX9 4QY
Tel: 01844-351694 Fax: 01844-352554
Email: enquires@mauritron.co.uk

1

[PHOTO BOARD]

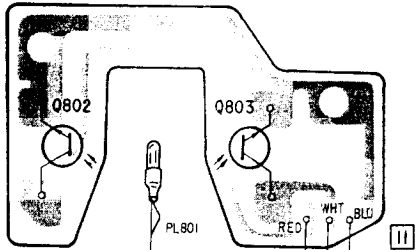

2

[CASSETTE BOARD]

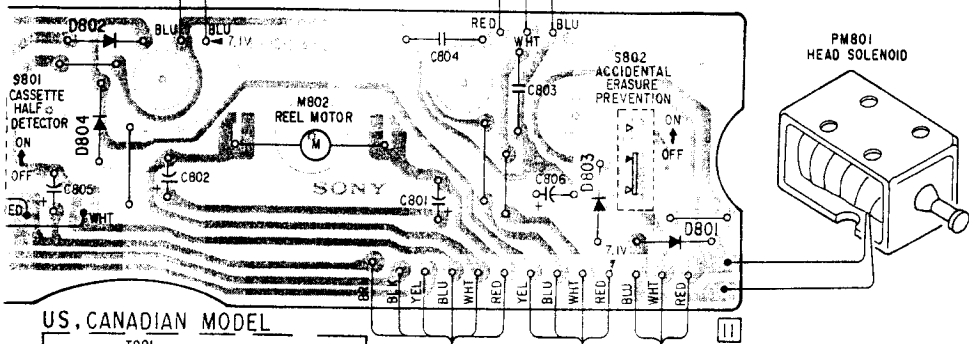

3

US, CANADIAN MODEL

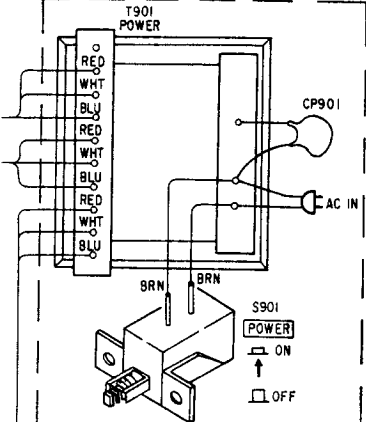

AEP, UK MODEL

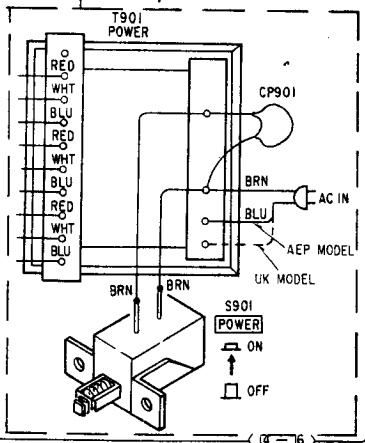

4

5

Note:

- ○ — : parts extracted from the component side.
- ● — : parts extracted from the conductor side.
- ○ — : 8+ pattern
- See page 45 for Semiconductor Lead Layouts.

4.4. SCHEMATIC DIAGRAM

— System Control Section —

A

B

C

D

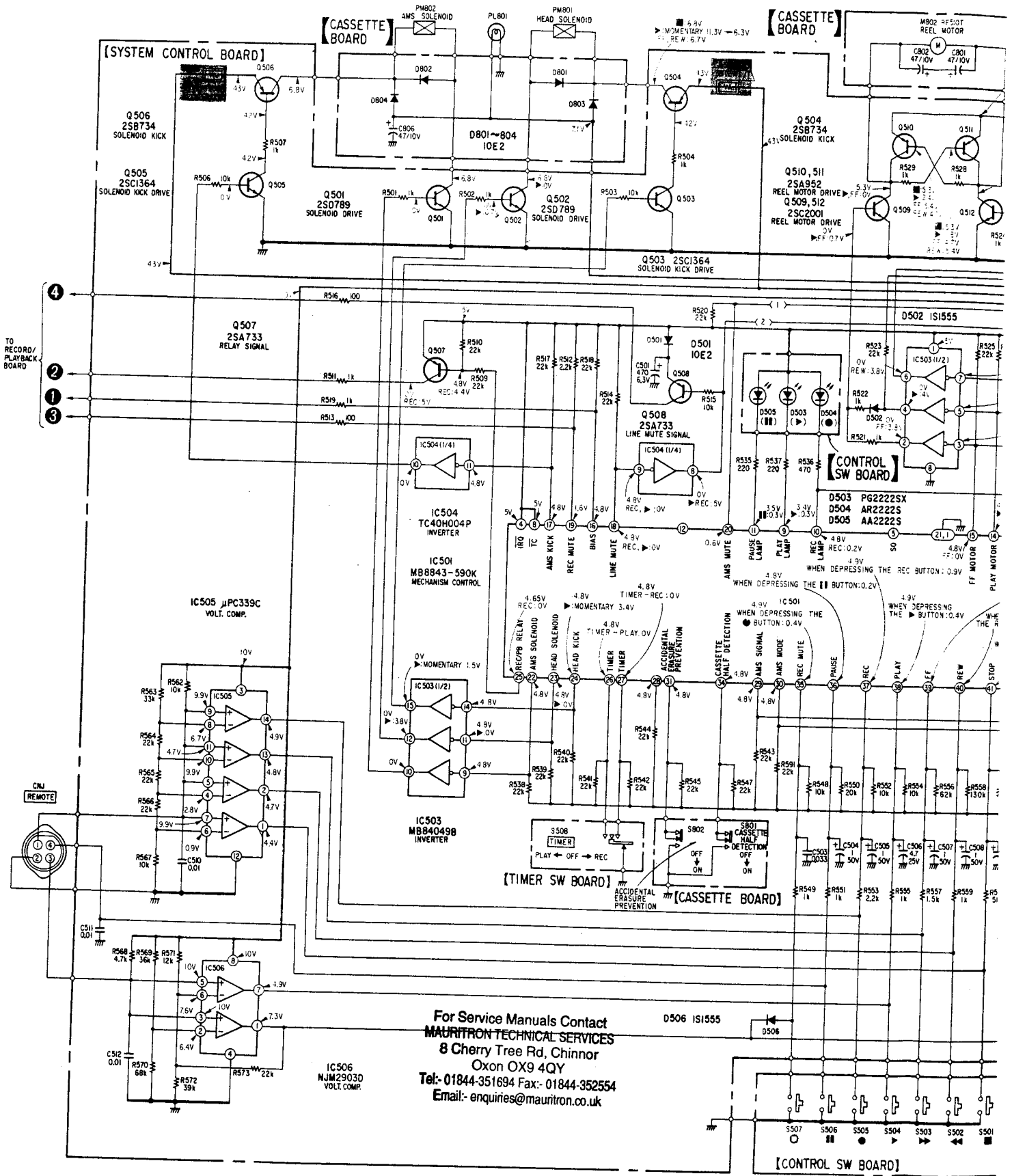

For Service Manuals Contact
MAURITRON TECHNICAL SERVICES
 8 Cherry Tree Rd, Chinnor
 Oxon OX9 4QY
 Tel: 01844-351694 Fax: 01844-352554
 Email: enquiries@mauritron.co.uk

TC-FX77 TC-FX77

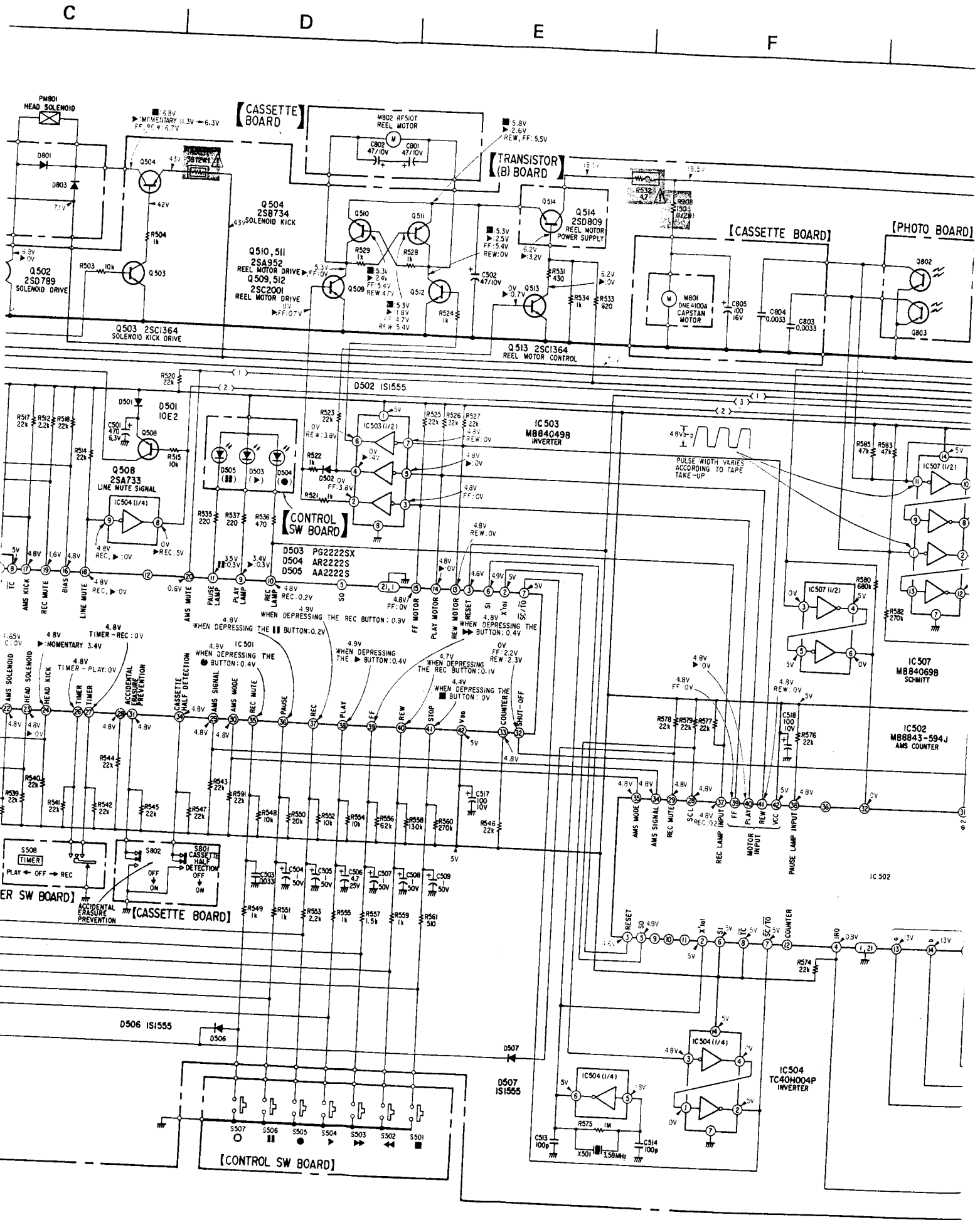

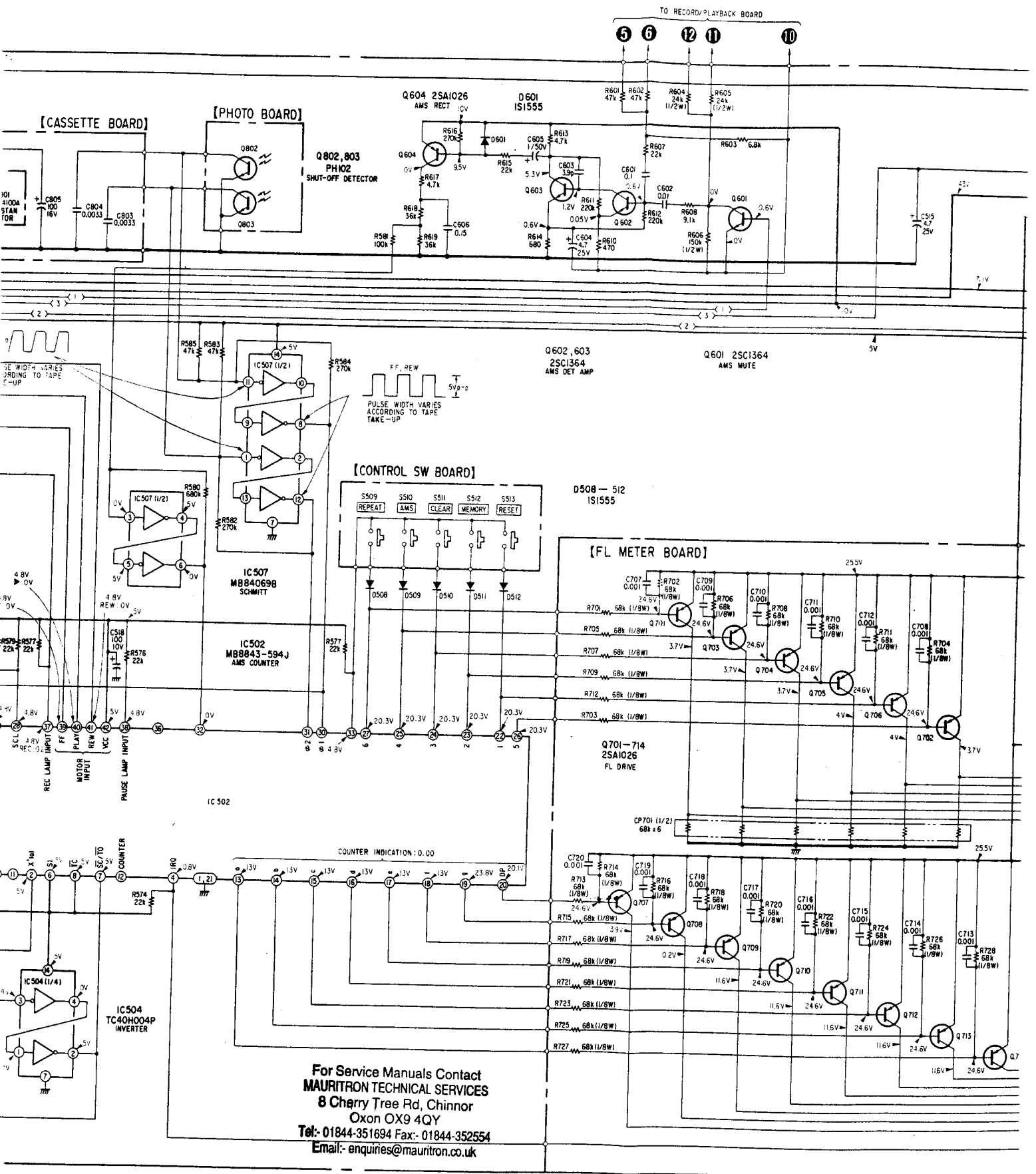

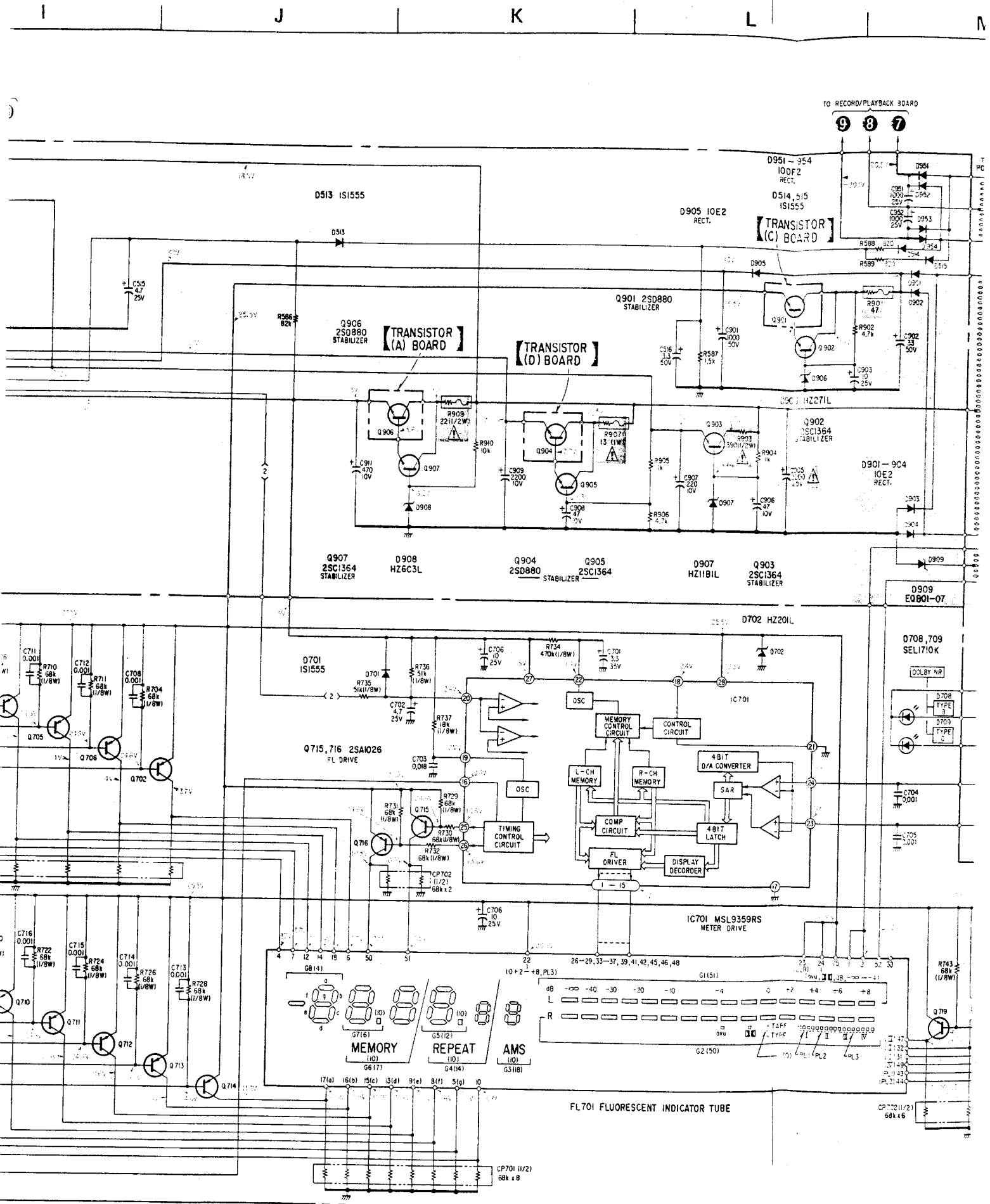

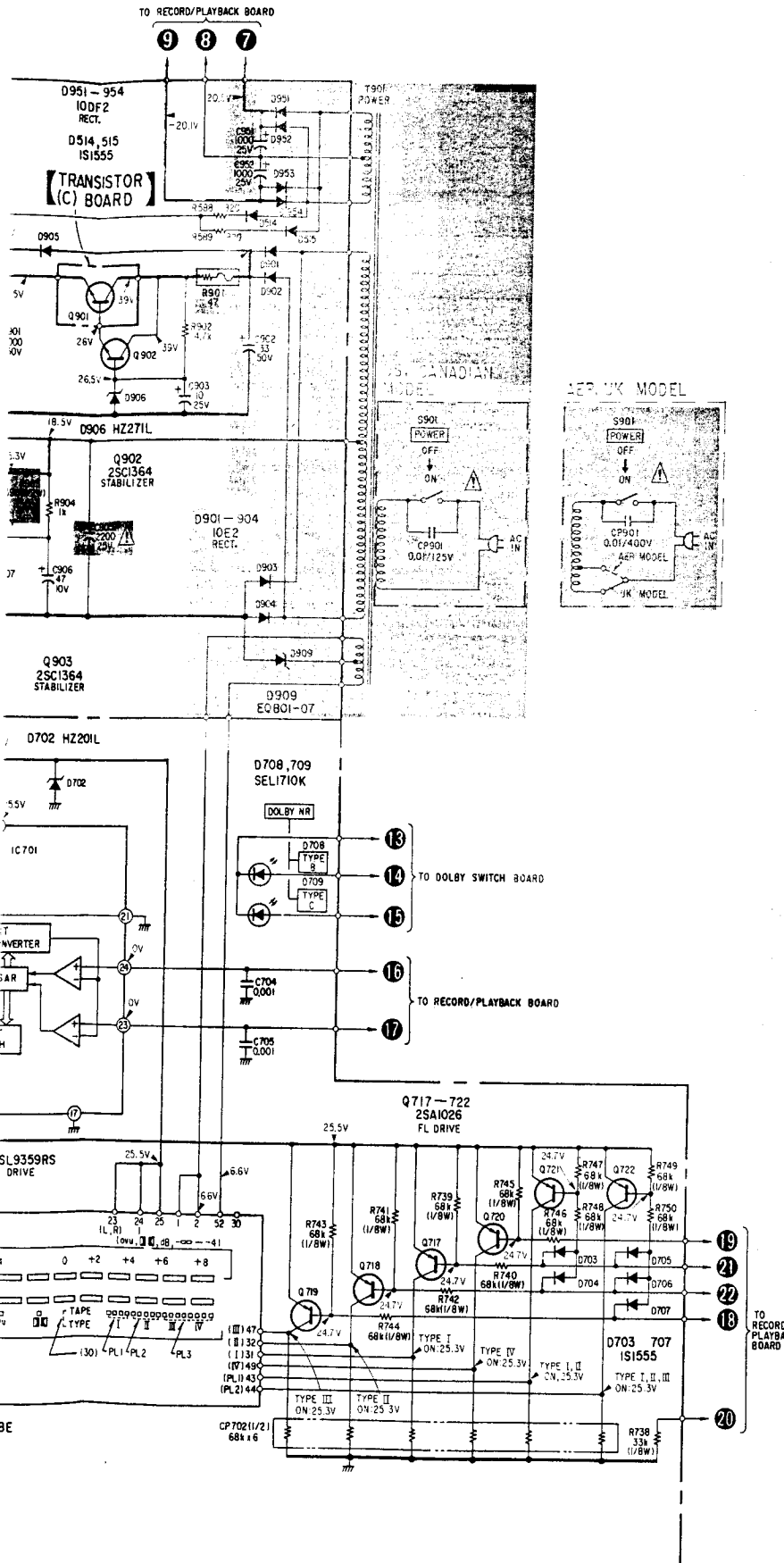

Note:

- All capacitors are in μF unless otherwise noted. $pF : \mu\mu F$ 50WV or less are not indicated except for electrolytics and tantalums.
- All resistors are in ohms, $\frac{1}{4}W$ unless otherwise noted. $k\Omega : 1000\Omega$, $M\Omega : 1000k\Omega$
- : nonflammable resistor.
- : fusible resistor.
- : panel designation.
- : adjustment for repair.
- Readings are taken under no-signal conditions with a VOM (50 $k\Omega/V$).
- Switch

Ref. No.	Switch	Position
S101-507	Function	OFF
S508	TIMER	OFF
S509	REPEAT	OFF
S510	AMS	OFF
S511	CLEAR	OFF
S512	MEMORY	OFF
S513	RESET	OFF
S801	Cassette Half Detector	OFF
S802	Erase Proof	OFF
S901	POWER	OFF

Note: The components identified by shading and mark are critical for safety. Replace only with part number specified.

Note: Les composants identifiés par une trame et une marque sont critiques pour la sécurité. Ne les remplacer que par une pièce portant le numéro spécifié.

For Service Manuals Contact
MAURITRON TECHNICAL SERVICES
 8 Cherry Tree Rd, Chinnor
 Oxon OX9 4QY
 Tel: 01844-351694 Fax: 01844-352554
 Email: enquiries@mauritron.co.uk

SECTION 5
EXPLODED VIEWS AND PARTS LIST

• SEMICONDUCTOR LEAD LAYOUTS

<p>2SA733 2SA844 2SC945 2SC1345 2SC1363 2SC1364 2SC2001 2SD789 2SD1152</p>	<p>2SA952</p>	<p>2SA1026 2SA1027R</p>	<p>2SB734 2SD774</p>	<p>2SB648 2SD414 2SD809</p> <p>letter side</p>	<p>2SD880</p>	<p>2SK120</p>	<p>PH102</p>	<p>BA6138</p>	<p>CX174-2 MB8045B MB8843-590 MB8843-594 NJM2903D NJM4558S MSL9359RS</p> <p>(Top view)</p>	<p>MS218L</p>	<p>NJM2043S-D</p>
--	---------------	-----------------------------	--------------------------	--	---------------	---------------	--------------	---------------	--	---------------	-------------------

For Service Manuals Contact
MAURITRON TECHNICAL SERVICES
8 Cherry Tree Rd, Chinnor
Oxon OX9 4QY
Tel:- 01844-351694 Fax:- 01844-352554
Email:- enquiries@mauritron.co.uk

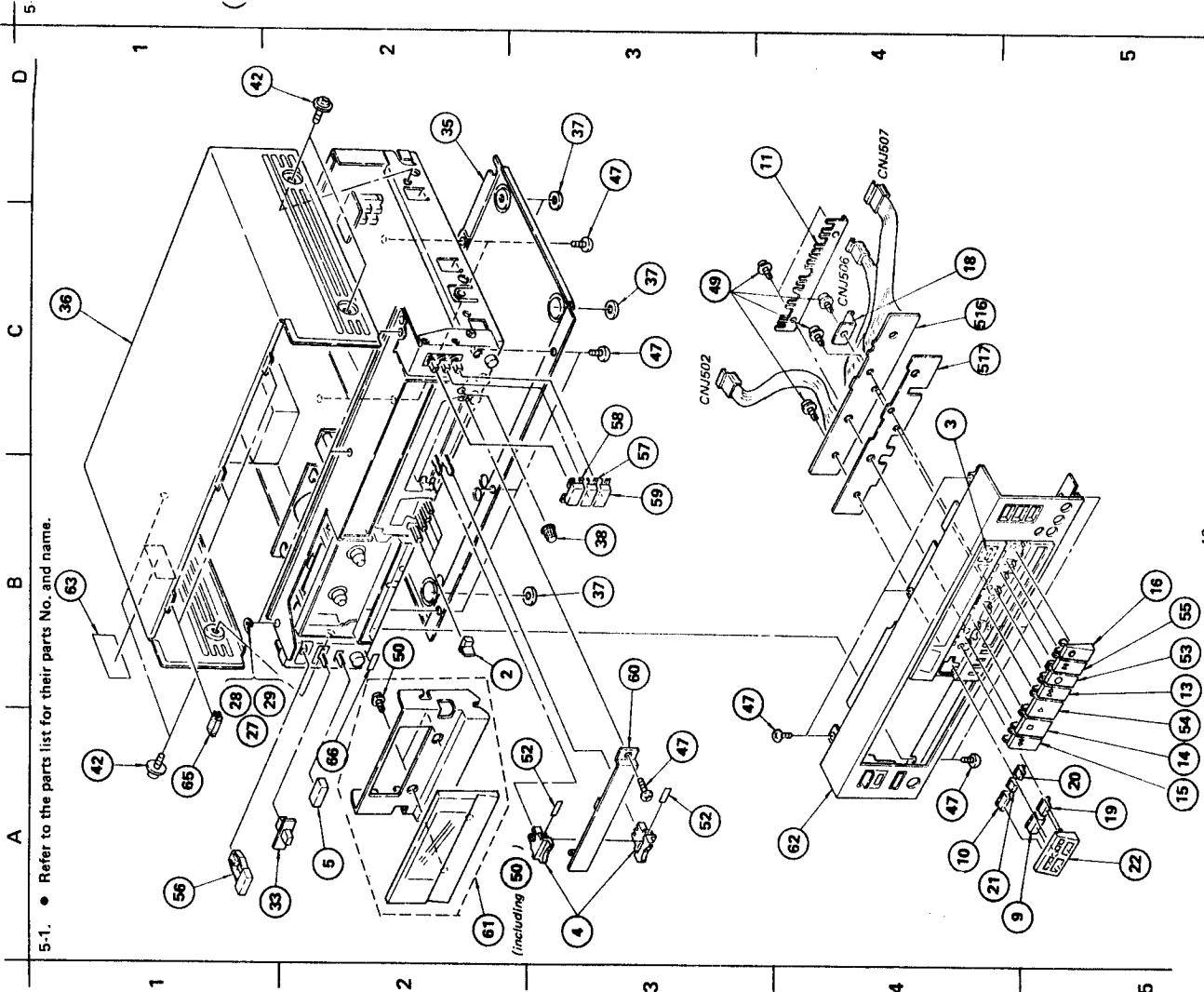

A

B

C

D

5-3. • Refer to the parts list for their parts No. and name.

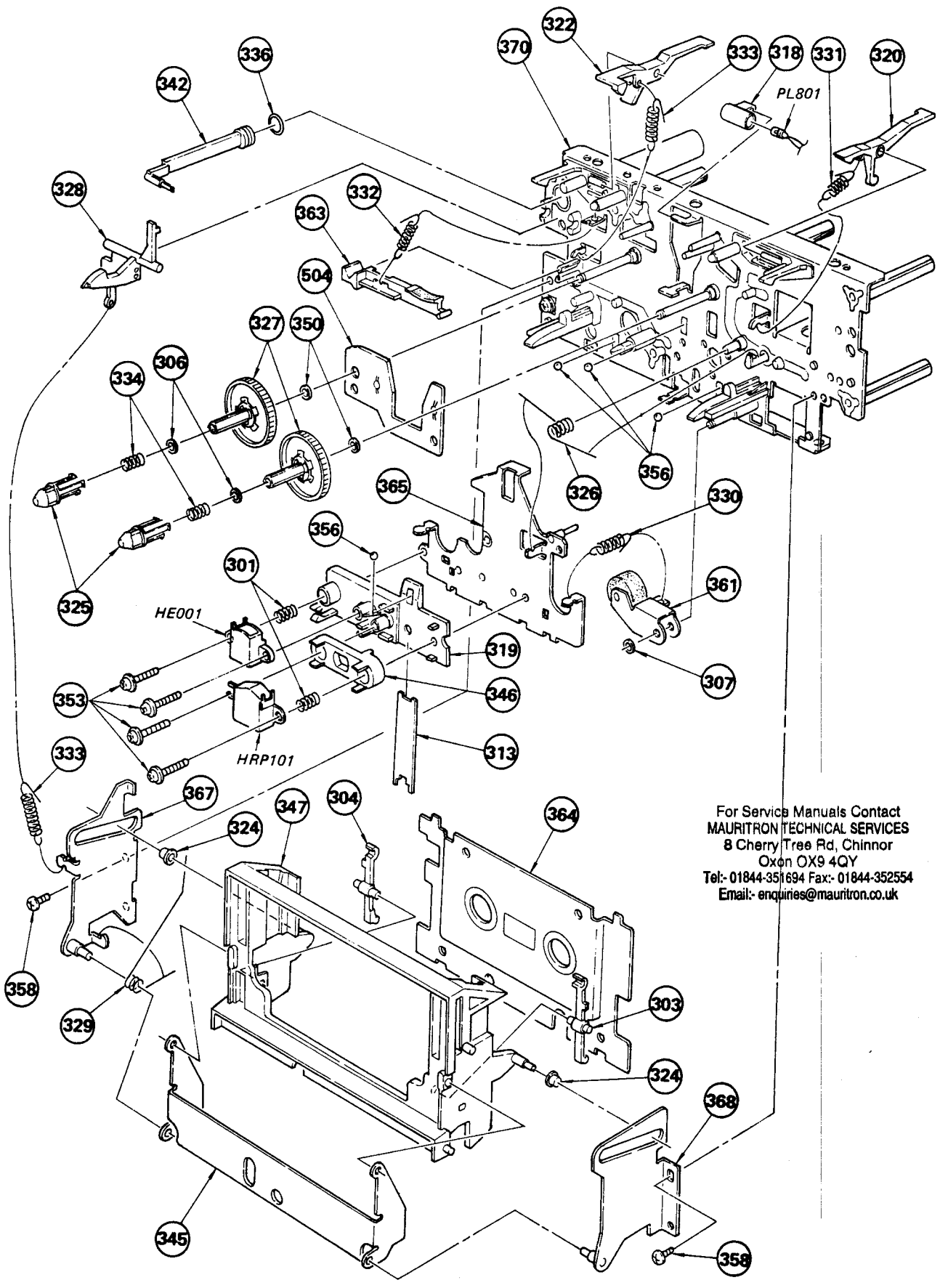

For Service Manuals Contact
MAURITRON TECHNICAL SERVICES
8 Cherry Tree Rd, Chinnor
Oxon OX9 4QY
Tel:- 01844-351694 Fax:- 01844-352554
Email:- enquiries@mauritron.co.uk

For Service Manuals Contact
MAURITRON TECHNICAL SERVICES
 8 Cherry Tree Rd, Chinnor
 Oxon OX9 4QY
 Tel: 01844-351694 Fax: 01844-352554
 Email: enquiries@mauritron.co.uk

GENERAL SECTION

GENERAL SECTION

No.	Part No.	Description
1	2-259-121-00	SCREW, TR
2	3-304-401-00	KNOB, TAPE SELECT
3	♣;3-304-407-00	ILLUMINATOR
4	3-304-418-00	BUTTON, REC CONTROL
5	3-304-419-00	BUTTON, EJECT
6	♣;3-304-421-03	JOINT
7	♣;3-304-422-11	(US,Canadian)...PLATE, JACK
7	♣;3-304-446-00	(AEP,UK).....PLATE, JACK
8	♣;3-304-423-00	PLATE, SIDE, LEFT
9	3-304-425-00	BUTTON, RESET
10	3-304-426-00	BUTTON, MEMORY
11	♣;3-304-428-00	SPRING
12	♣;3-304-429-00	PLATE, RELAY
13	3-304-433-00	BUTTON, FF
14	3-304-437-00	BUTTON, STOP
15	3-304-438-00	BUTTON, REW
16	3-304-439-00	BUTTON, REC MUTE
17	♣;3-304-440-02	CHASSIS, AMPLIFIER
18	♣;3-304-441-00	SPRING
19	3-304-702-00	BUTTON, CLEAR
20	3-304-703-01	BUTTON, AMS
21	3-304-703-11	BUTTON, AMS
22	3-304-704-00	ESCUTCHEON, BUTTON, COUNTER
23	♣;3-304-701-00	CASE, SHIELD
24	3-304-710-00	(US,Canadian)...LABEL, SPECIFICATION
24	3-304-711-00	(AEP).....LABEL, SPECIFICATION
24	3-304-712-00	(UK).....LABEL, SPECIFICATION
♣25-1	3-304-714-00	SHEET (SMALL), INSULATING
♣25-2	3-304-715-00	SHEET (LARGE), INSULATING
26	3-534-238-XX	SPRING, TENSION
27	3-544-028-01	SPACER
28	3-544-028-11	SPACER
29	3-544-028-21	SPACER
30	♣;3-567-242-00	HEAT SINK
31	♣;3-575-501-00	SLIDER, EJECT
32	♣;3-575-502-00	BRACKET, EJECT
33	3-575-515-00	KNOB, SLIDE SWITCH
34	♣;3-575-529-11	PLATE, SIDE, RIGHT
35	3-575-538-00	PLATE, BOTTOM
36	3-575-539-00	CASE
37	3-576-731-00	FELT (H)
38	3-579-334-00	KNOB, HEADPHONE
39	3-701-682-00	(US,Canadian)...STOPPER, CORD
39	3-703-244-00	(AEP,UK).....STOPPER, CORD
40	3-703-037-00	INSULATOR, TO-220

No.	Part No.	Description
41	3-703-486-00	+PTWH 3X5
42	4-820-330-21	SCREW, BW, PLUS MINUS
43	7-628-253-95	SCREW +PS 2.6X4
44	7-682-147-20	SCREW +P 3X6
45	7-682-446-01	SCREW +PS 3X5
46	7-685-647-29	SCREW +BVTP 3X10 TYPE2 SLIT
47	7-685-871-01	SCREW +BVTT 3X6 (S)
48	7-685-871-09	SCREW +BVTT 3X6 (S)
49	7-687-203-21	TOTSU PTPWH 2X5, TYPE2, SLIT
50	7-687-232-21	TOTSU PTPWH 2.6X5, TYPE2, SLIT
51	9-911-837-XX	CUSHION, FILTER
52	9-911-841-XX	CUSHION
53	X-3304-401-0	BUTTON (A) ASSY, REC
54	X-3304-402-0	BUTTON ASSY, PAUSE
55	X-3304-403-0	BUTTON ASSY, FAWE
56	X-3304-405-0	KNOB ASSY, POWER
57	X-3304-406-1	KNOB ASSY, PUSH
58	X-3304-406-2	KNOB ASSY, PUSH
59	X-3304-406-3	KNOB ASSY, PUSH
60	X-3304-407-0	PLATE ASSY, ORNAMENTAL
61	X-3304-408-2	LID ASSY, CASSETTE
62	X-3304-702-1	PANEL ASSY
63	3-703-079-21	(US,UK)....LABEL, CAUTION (BACK)
64	4-875-455-21	(AEP,UK)...COVER, CAPACITOR
65	3-831-441-XX	CUSHION
66	3-701-690-00	(UK)...LABEL (MADE IN JAPAN)
67	7-685-872-01	SCREW +BVTT 3X8

ACCESSORY & PACKING MATERIAL

No.	Part No.	Description
91	1-551-734-11	CORD, CONNECTION (RK- 74A)
92	3-304-716-00	INDIVIDUAL CARTON
93	3-573-625-00	SHEET, POLYETHYLENE
94	3-575-564-00	CUSHION
95	3-701-630-00	BAG, POLYETHYLENE
96	3-783-843-11	(AEP, UK).....MANUAL, INSTRUCTION
97	3-783-843-21	(US,Canadian)...MANUAL, INSTRUCTION
98	3-783-843-31	(Canadian).....MANUAL, INSTRUCTION
99	3-783-843-41	(AEP).....MANUAL, INSTRUCTION, DUTCH
100	3-793-828-11	QUESTIONNAIRE
101	X-3701-105-0	ROD ASSY, CLEANING, HEAD

NOTE:

• Items with no part number and no description are not stocked because they are seldom required for routine service.

• Items marked "♣" are not stocked since they are seldom required for routine service. Some delay should be anticipated when ordering these items.

• Due to standardization, parts with part numbers (Δ-ΔΔΔ-ΔΔΔ-XX or Δ-ΔΔΔΔ-ΔΔΔ-X) may be different from those used in the set.

CAPACITORS:

• All capacitors are in μF. Common capacitors are omitted. Refer to the following lists for their part numbers.
 MF:μF, PF:μμF.

RESISTORS

• All resistors are in ohms. Common 1/4W, 1/8W and 1/16W carbon resistors are omitted. Refer to the following lists for their part numbers.

• F : nonflammable

COILS

• MMH : mH, UH : μH

The components identified by shading and mark **Δ** are critical for safety. Replace only with part number specified.

Les composants identifiés par une trame et une marque **Δ** sont critiques pour la sécurité. Ne les remplacer que par une pièce portant le numéro spécifié.

SEMICONDUCTORS

In each case, U : μ, for example:
 UA.... : μA...., UPA.... : μPA...., UPC.... : μPC,
 UPD.... : μPD....

MECHANISM SECTION

No.	Part No.	Description
301	3-481-272-00	SPRING, COMPRESSION
302	3-538-051-00	RUBBER, BRAKE
303	3-555-113-00	SPRING (RIGHT)
304	3-555-114-00	SPRING (LEFT)
305	3-558-708-01	WASHER, STOPPER
306	3-558-708-11	WASHER, STOPPER
307	3-558-708-21	WASHER, STOPPER
308	3-564-027-11	FELT, LIMITER
309	3-564-319-00	BELT, CAPSTAN
310	♣;3-575-302-00	RETAINER, THRUST
311	3-575-304-00	SHAFT, GEAR, FR
312	♣;3-575-307-00	LEVER, FWD
313	♣;3-575-312-00	SPRING
314	3-575-318-00	LEVER, LOCK TUNING
315	3-575-321-00	RETAINER, THRUST, CAPSTAN
316	3-575-324-00	GEAR, LIMITER
317	3-575-327-00	STOPPER
318	3-575-328-00	HOLDER, LAMP
319	3-575-330-00	BRACKET, HEAD
320	♣;3-575-331-00	LEVER, DETECTION, HALF
321	3-575-332-00	GEAR, FR
322	♣;3-575-334-00	LEVER, DETECTION, REC
323	3-575-345-00	SPRING
324	3-575-348-00	ROLLER, GUIDE, THREADING
325	3-575-350-00	CLAW, REEL TABLE
326	3-575-351-00	SPRING
327	3-575-353-11	TABLE, REEL
328	3-575-354-00	LEVER, LOCK
329	3-575-356-00	SPRING
330	3-575-357-00	SPRING, TENSION
331	3-575-358-00	SPRING, TENSION
332	3-575-359-00	SPRING, TENSION
333	3-575-364-00	SPRING, TENSION
334	3-575-365-00	SPRING, COMPRESSION
335	3-575-368-00	SPRING, COMPRESSION
336	3-575-392-00	RING, PISTON
337	3-575-414-00	SPRING, COMPRESSION
338	3-575-415-11	ARBOR, MOVABLE
339	3-575-416-11	ARBOR, FIXED
340	3-575-457-00	PLATE (B), SHIELD, MOTOR
341	3-575-458-00	SPRING
342	3-575-459-00	PISTON
343	3-575-460-00	LEVER, SELECT TUNE
344	3-575-469-00	SHOE, BRAKE
345	♣;3-575-470-00	LEVER, HOLDER FULCRUM

MECHANISM SECTION

No.	Paer No.	Description
346	3-575-471-00	TABLE, ADJUSTMANT, HEAD
347	3-575-472-00	HOLDER, CASSETTE
348	3-652-612-11	CUSHION (B)
349	3-701-438-21	WASHER
350	3-701-439-21	WASHER
351	3-701-444-11	WASHER, 6
352	7-621-259-15	SCREW +P 2.6X3
353	7-621-772-70	SCREW +B 2X14
354	7-621-775-10	SCREW +B 2.6X4
355	7-624-110-04	STOP RING 6.0, TYPE -E
356	7-671-112-11	BALL, STEEL
357	7-682-949-01	SCREW +PSW 3X10
358	7-685-861-01	SCREW +BVTT 2.6X5 (S)
359	7-687-246-21	SCREW, TOTSU PTPWH 3X8,TYPE2
360	X-3575-303-0	METAL ASSY, CAPSTAN
361	X-3575-304-0	PINCH LEVER (T) ASSY
362	X-3575-305-0	FLYWHEEL (T) ASSY
363	X-3575-310-0	LEVER ASSY, TENSION, BACK
364	X-3575-314-0	PLATE ASSY, ORNAMENTAL
365	X-3575-324-0	CHASSIS ASSY, HEAD
366	X-3575-328-1	PULLEY, MOTOR
367	♣;X-3575-338-0	PLATE (LEFT) ASSY, FULCRUM
368	♣;X-3575-339-0	PLATE (RIGHT) ASSY, FULCRUM
369	♣;X-3575-342-0	PLATE ASSY, BRAKE
370	♣;X-3575-343-0	CHASSIS ASSY, MECHANISM
371	X-3575-348-0	MOTOR ASSY, REEL
372	3-701-437-21	WASHER, PLASTIC, 2mm dia.

For Service Manuals Contact
MAURITRON TECHNICAL SERVICES
 8 Cherry Tree Rd, Chinnor
 Oxon OX9 4QY
 Tel: 01844-351694 Fax: 01844-352554
 Email: enquiries@mauritron.co.uk

NOTE:

- Items with no part number and no description are not stocked because they are seldom required for routine service.
- Items marked "♣" are not stocked since they are seldom required for routine service. Some delay should be anticipated when ordering these items.
- Due to standardization, parts with part numbers (Δ-ΔΔΔ-ΔΔΔ-XX or Δ-ΔΔΔΔ-ΔΔΔ-X) may be different from those used in the set.

CAPACITORS:

- All capacitors are in μF . Common capacitors are omitted. Refer to the following lists for their part numbers.
 MF: μF , PF: μF .

RESISTORS

- All resistors are in ohms. Common 1/4W, 1/8W and 1/16W carbon resistors are omitted. Refer to the following lists for their part numbers.

- F : nonflammable

COILS

- MMH : mH, UH : μH

The components identified by shading and mark Δ are critical for safety. Replace only with part number specified.

Les composants identifiés par une trame et une marque Δ sont critiques pour la sécurité. Ne les remplacer que par une pièce portant le numéro spécifié.

SEMICONDUCTORS

In each case, U : μ , for example:
 UA... : μA ..., UPA... : μPA ..., UPC... : μPC ,
 UPD... : μPD ...

ELECTRICAL PARTS

Ref.No.	Part No.	Description				
501	1-507-761-00	JACK, PIN 4P				
502	♣;1-535-116-00	TERMINAL				
503	△.1-534-817-XX	(AEP).....CORD, POWER				
503	△.1-534-986-XX	(US,Canadian)...CORD, POWER				
503	△.1-551-884-00	(UK).....CORD, POWER				
504	♣;1-603-823-00	PC BOARD, PHOTO				
505	♣;1-606-086-00	PC BOARD, SWITCH				
506	♣;1-606-620-00	PC BOARD, REC VR				
507	♣;1-606-621-00	PC BOARD, PIN JACK				
508	♣;1-606-622-00	PC BOARD, DOLBY SWITCH				
509	♣;1-606-623-00	PC BOARD, RECORD EQ				
510	♣;1-606-624-00	PC BOARD, HEADPHONE VR				
511	♣;1-606-825-00	PC BOARD, TIMER SW				
512	♣;1-606-826-00	PC BOARD, TRANSISTOR (A)				
513	♣;1-606-827-00	PC BOARD, TRANSISTOR (B)				
514	♣;1-606-828-00	PC BOARD, TRANSISTOR (C)				
515	♣;1-606-829-00	PC BOARD, TRANSISTOR (D)				
516	1-606-831-00	PC BOARD, CONTROL SW				
517	1-606-832-00	PC BOARD, SHEET SW				
518	♣;A-2029-079-A	MOUNTED PCB, FL METER				
519	♣;A-2010-208-A	MOUNTED PCB, RECORD/PLAYBACK				
520	♣;A-2019-140-A	MOUNTED PCB, SYSTEM CONTROL				
C001	△.1-123-695-00	ELECT	330MF	20%	25V	
C002	△.1-123-695-00	ELECT	330MF	20%	25V	
C115	1-130-620-00	FILM	0.01MF	5%	50V	
C121	1-161-318-00	CERAMIC	390PF	10%	50V	
C122	1-161-318-00	CERAMIC	390PF	10%	50V	
C123	1-161-318-00	CERAMIC	390PF	10%	50V	
C125	1-123-829-00	ELECT	2.2MF	20%	50V	
C130	1-130-305-00	FILM	0.022MF	5%	100V	
C131	1-123-829-00	ELECT	2.2MF	20%	50V	
C215	1-130-620-00	FILM	0.01MF	5%	50V	
C221	1-161-318-00	CERAMIC	390PF	10%	50V	
C222	1-161-318-00	CERAMIC	390PF	10%	50V	
C223	1-161-318-00	CERAMIC	390PF	10%	50V	
C225	1-123-829-00	ELECT	2.2MF	20%	50V	
C230	1-130-305-00	FILM	0.022MF	5%	100V	
C231	1-123-829-00	ELECT	2.2MF	20%	50V	
C303	1-130-634-00	FILM	0.15MF	5%	50V	
C304	1-130-632-00	FILM	0.1MF	5%	50V	
C305	1-130-632-00	FILM	0.1MF	5%	50V	
C306	1-130-621-00	FILM	0.012MF	5%	50V	
C310	1-130-851-00	FILM	0.082MF	3%	100V	

ELECTRICAL PARTS

Ref.No.	Part No.	Description				
C312	1-130-341-00	FILM	0.056MF	3%	100V	
C313	1-130-857-00	FILM	0.047MF	3%	100V	
C314	1-130-856-00	FILM	0.0068MF	3%	100V	
C317	1-130-634-00	FILM	0.15MF	5%	50V	
C318	1-130-628-00	FILM	0.047MF	5%	50V	
C319	1-130-625-00	FILM	0.027MF	5%	50V	
C327	1-130-623-00	FILM	0.018MF	5%	50V	
C330	1-123-830-00	ELECT	4.7MF	20%	50V	
C403	1-130-634-00	FILM	0.15MF	5%	50V	
C404	1-130-632-00	FILM	0.1MF	5%	50V	
C405	1-130-632-00	FILM	0.1MF	5%	50V	
C406	1-130-621-00	FILM	0.012MF	5%	50V	
C410	1-130-851-00	FILM	0.082MF	3%	100V	
C412	1-130-341-00	FILM	0.056MF	3%	100V	
C413	1-130-857-00	FILM	0.047MF	3%	100V	
C414	1-130-856-00	FILM	0.0068MF	3%	100V	
C415	1-108-570-00	MYLAR	0.0043MF	5%	50V	
C417	1-130-634-00	FILM	0.15MF	5%	50V	
C418	1-130-628-00	FILM	0.047MF	5%	50V	
C419	1-130-625-00	FILM	0.027MF	5%	50V	
C427	1-130-623-00	FILM	0.018MF	5%	50V	
C430	1-123-830-00	ELECT	4.7MF	20%	50V	
C517	1-119-352-00	ELECT	100MF		10V	
C518	1-119-352-00	ELECT	100MF		10V	
C603	1-161-254-00	CERAMIC	3.9PF	10%	50V	
C902	△.1-123-372-00	ELECT	1000MF	20%	25V	
C905	△.1-123-338-00	ELECT	2200MF	20%	25V	
C951	△.1-123-697-00	ELECT	1000MF	20%	25V	
C952	△.1-123-697-00	ELECT	1000MF	20%	25V	
CNJ	1-561-293-00	SOCKET (4P), REMOTE				
♣CNP001	1-508-878-00	BASE POST				
♣CNP002	1-560-060-00	PIN, CONNECTOR 2P				
♣CNP501	1-560-063-00	PIN, CONNECTOR 5P				
♣CNP502	1-560-064-00	PIN, CONNECTOR 6P				
♣CNP503	1-560-338-00	PIN, CONNECTOR 7P				
♣CNP504	1-560-066-00	PIN, CONNECTOR 10P				
♣CNP505	1-560-062-00	PIN, CONNECTOR 4P				
♣CNP506	1-560-063-00	PIN, CONNECTOR 5P				
♣CNP507	1-560-065-00	PIN, CONNECTOR 8P				
♣CNP508	1-560-062-00	PIN, CONNECTOR 4P				
♣CNP509	1-560-063-00	PIN, CONNECTOR 5P				
♣CNP510	1-560-338-00	PIN, CONNECTOR 7P				
♣CNP511	1-560-064-00	PIN, CONNECTOR 6P				
♣CNP701	1-560-709-00	PIN, CONNECTOR 8P				

NOTE:

- Items with no part number and no description are not stocked because they are seldom required for routine service.
- Items marked "♣" are not stocked since they are seldom required for routine service. Some delay should be anticipated when ordering these items.
- Due to standardization, parts with part numbers (△-△△△-△△△-XX or △-△△△△-△△△-X) may be different from those used in the set.

CAPACITORS:

- All capacitors are in μF . Common capacitors are omitted. Refer to the following lists for their part numbers. MF: μF , PF: $\mu\mu\text{F}$.

RESISTORS

- All resistors are in ohms. Common 1/4W, 1/8W and 1/16W carbon resistors are omitted. Refer to the following lists for their part numbers.

- F : nonflammable

COILS

- MMH : mH, UH : μH

The components identified by shading and mark △ are critical for safety. Replace only with part number specified.

Les composants identifiés par une trame et une marque △ sont critiques pour la sécurité. Ne les remplacer que par une pièce portant le numéro spécifié.

SEMICONDUCTORS

- In each case, U : μ , for example: UA...: μA ..., UPA...: μPA ..., UPC...: μPC , UPD...: μPD ...

ELECTRICAL PARTS

Ref.No.	Part No.	Description
CP001	1-464-110-00	OSCILLATOR UNIT, BIAS
CP001	1-464-110-00	OSCILLATOR UNIT, BIAS
CP901A	1-161-749-00	(US,Canadian)..CAP, CERAMIC 0.01MF 125V
CP901A	1-161-744-00	(AEP,UK).....CAP, CERAMIC 0.01MF 400V
CT001	1-141-225-00	CAP, TUNING, TRIMAR
D001	8-719-910-64	DIODE HZ681L
D002	8-719-910-64	DIODE HZ681L
D003	8-719-910-74	DIODE HZ781L
D004	8-719-815-55	DIODE 1S1555
D005	8-719-815-55	DIODE 1S1555
D008	8-719-815-55	DIODE 1S1555
D501	8-719-200-02	DIODE 10E-2
D502	8-719-815-55	DIODE 1S1555
D503	8-719-922-23	DIODE PG2222SX
D504	8-719-922-21	DIODE AR2222S
D506	8-719-815-55	DIODE 1S1555
D507	8-719-815-55	DIODE 1S1555
D508	8-719-815-55	DIODE 1S1555
D509	8-719-815-55	DIODE 1S1555
D510	8-719-815-55	DIODE 1S1555
D511	8-719-815-55	DIODE 1S1555
D512	8-719-815-55	DIODE 1S1555
D513	8-719-815-55	DIODE 1S1555
D514	△.8-719-815-55	DIODE 1S1555
D515	△.8-719-815-55	DIODE 1S1555
D601	8-719-815-55	DIODE 1S1555
D701	8-719-815-55	DIODE 1S1555
D702	8-719-910-01	DIODE HZ20-1L
D703	8-719-815-55	DIODE 1S1555
D704	8-719-815-55	DIODE 1S1555
D705	8-719-815-55	DIODE 1S1555
D706	8-719-815-55	DIODE 1S1555
D707	8-719-815-55	DIODE 1S1555
D708	8-719-317-10	DIODE SEL1710K
D709	8-719-317-10	DIODE SEL1710K
D801	8-719-200-02	DIODE 10E-2
D802	8-719-200-02	DIODE 10E-2
D803	8-719-200-02	DIODE 10E-2
D804	8-719-200-02	DIODE 10E-2
D901	△.8-719-200-02	DIODE 10E-2
D902	△.8-719-200-02	DIODE 10E-2
D903	△.8-719-200-02	DIODE 10E-2
D904	△.8-719-200-02	DIODE 10E-2
D905	8-719-200-02	DIODE 10E-2

For Service Manuals Contact
MAURITRON TECHNICAL SERVICES
 8 Cherry Tree Rd, Chinnor
 Oxon OX9 4QY
 Tel: 01844-351694 Fax: 01844-352554
 Email: enquiries@mauritron.co.uk

ELECTRICAL PARTS

Ref.No.	Part No.	Description
D906	8-719-992-71	DIODE HZ27-1L
D907	8-719-910-14	DIODE HZ11B1L
D908	8-719-910-69	DIODE HZ6C3L
D909	△.8-719-931-07	DIODE EQB01-07
D951	△.8-719-210-12	DIODE 10DF2
D952	△.8-719-210-12	DIODE 10DF2
D953	△.8-719-210-12	DIODE 10DF2
D954	△.8-719-210-12	DIODE 10DF2
FL701	1-519-248-00	INDICATOR TUBE, FLUORESCENT
HRP101	8-825-529-20	HEAD, REC/PB
HE001	8-825-724-00	HEAD, ERASE EF-201-36
IC001	8-759-700-05	IC NJM2043S-D
IC002	8-759-961-38	IC BA6138
IC003	8-759-700-08	IC NJM4558S
IC004	8-759-600-02	IC M5218L
IC301	8-759-300-74	IC CX-174-2
IC302	8-759-300-74	IC CX-174-2
IC401	8-759-300-74	IC CX-174-2
IC402	8-759-300-74	IC CX-174-2
IC501	8-759-900-80	IC MB8843-590
IC502	8-759-900-81	IC MB8843-594
IC503	8-759-140-49	IC MB84049B
IC504	8-759-220-04	IC TC40H004P
IC505	8-759-133-90	IC UPC339C
IC506	8-759-729-03	IC NJM2903D
IC507	8-759-984-69	IC MB84069UB
IC701	8-759-904-72	IC MSL9359RS
J002	1-507-649-00	JACK, HEADPHONES
J101	1-507-648-00	JACK, MIC/L
J201	1-507-648-00	JACK, MIC/R
L001	1-407-177-XX	MICRO INDUCTOR 470UH
L002	1-407-177-XX	MICRO INDUCTOR 470UH
L101	1-408-262-00	MICRO INDUCTOR 27MMH
L201	1-408-262-00	MICRO INDUCTOR 27MMH
L301	1-408-259-00	MICRO INDUCTOR 15MMH
L401	1-408-259-00	MICRO INDUCTOR 15MMH
LPF101	1-231-388-00	FILTER, LOWPASS
LPF201	1-231-388-00	FILTER, LOWPASS
M801	8-835-049-01	MOTOR, DC (DNE-4100A), CAPSTAN
PL801	1-518-340-71	LAMP, PILOT
PM801	1-454-301-00	SOLENOID, PLUNGER, HEAD
PM802	1-454-291-00	SOLENOID, PLUNGER, BRAKE

NOTE:

- Items with no part number and no description are not stocked because they are seldom required for routine service.
- Items marked "△" are not stocked since they are seldom required for routine service. Some delay should be anticipated when ordering these items.
- Due to standardization, parts with part numbers (Δ-ΔΔΔ-ΔΔΔ-XX or Δ-ΔΔΔΔ-ΔΔΔ-X) may be different from those used in the set.

CAPACITORS:

- All capacitors are in μF. Common capacitors are omitted. Refer to the following lists for their part numbers. MF:μF, PF:μμF.

RESISTORS

- All resistors are in ohms. Common 1/4W, 1/8W and 1/16W carbon resistors are omitted. Refer to the following lists for their part numbers.

- F : nonflammable

COILS

- MMH : mH, UH : μH

The components identified by shading and mark △ are critical for safety. Replace only with part number specified.

Les composants identifiés par une trame et une marque △ sont critiques pour la sécurité. Ne les remplacer que par une pièce portant le numéro spécifié.

SEMICONDUCTORS

- In each case, U : μ, for example:
 UA... : μA... , UPA... : μPA... , UPC... : μPC,
 UPD... : μPD...

ELECTRICAL PARTS

Ref.No.	Part No.	Description
Q001	8-769-112-00	TRANSISTOR 2SK120
Q002	8-769-112-00	TRANSISTOR 2SK120
Q003	8-729-141-43	TRANSISTOR 2SD414
Q004	8-729-315-22	TRANSISTOR 2SD1152
Q005	8-729-315-22	TRANSISTOR 2SD1152
Q006	8-729-154-83	TRANSISTOR 2SB548
Q007	8-729-384-48	TRANSISTOR 2SA844
Q008	8-729-384-48	TRANSISTOR 2SA844
Q010	8-729-612-77	TRANSISTOR 2SA1027R
Q011	8-729-612-77	TRANSISTOR 2SA1027R
Q012	8-729-663-47	TRANSISTOR 2SC1364
Q013	8-729-663-47	TRANSISTOR 2SC1364
Q101	8-729-334-58	TRANSISTOR 2SC1345
Q102	8-729-334-58	TRANSISTOR 2SC1345
Q103	8-729-663-47	TRANSISTOR 2SC1364
Q104	8-729-663-47	TRANSISTOR 2SC1364
Q201	8-729-334-58	TRANSISTOR 2SC1345
Q202	8-729-334-58	TRANSISTOR 2SC1345
Q203	8-729-663-47	TRANSISTOR 2SC1364
Q204	8-729-663-47	TRANSISTOR 2SC1364
Q301	8-729-663-47	TRANSISTOR 2SC1364
Q302	8-729-663-47	TRANSISTOR 2SC1364
Q303	8-729-663-47	TRANSISTOR 2SC1364
Q304	8-729-663-47	TRANSISTOR 2SC1364
Q305	8-729-663-47	TRANSISTOR 2SC1364
Q306	8-729-663-47	TRANSISTOR 2SC1364
Q307	8-729-663-47	TRANSISTOR 2SC1364
Q308	8-729-663-47	TRANSISTOR 2SC1364
Q309	8-729-663-47	TRANSISTOR 2SC1364
Q310	8-729-100-13	TRANSISTOR 2SC2001
Q311	8-729-663-47	TRANSISTOR 2SC1364
Q401	8-729-663-47	TRANSISTOR 2SC1364
Q402	8-729-663-47	TRANSISTOR 2SC1364
Q403	8-729-663-47	TRANSISTOR 2SC1364
Q404	8-729-663-47	TRANSISTOR 2SC1364
Q405	8-729-663-47	TRANSISTOR 2SC1364
Q406	8-729-663-47	TRANSISTOR 2SC1364
Q407	8-729-663-47	TRANSISTOR 2SC1364
Q408	8-729-663-47	TRANSISTOR 2SC1364
Q409	8-729-663-47	TRANSISTOR 2SC1364
Q410	8-729-100-13	TRANSISTOR 2SC2001
Q411	8-729-663-47	TRANSISTOR 2SC1364
Q501	8-729-177-43	TRANSISTOR 2SD774
Q502	8-729-177-43	TRANSISTOR 2SD774
Q503	8-729-663-47	TRANSISTOR 2SC1364

ELECTRICAL PARTS

Ref.No.	Part No.	Description
Q504	8-729-103-43	TRANSISTOR 2SB734
Q505	8-729-663-47	TRANSISTOR 2SC1364
Q506	8-729-103-43	TRANSISTOR 2SB734
Q507	8-729-612-77	TRANSISTOR 2SA1027R
Q508	8-729-612-77	TRANSISTOR 2SA1027R
Q509	8-729-100-13	TRANSISTOR 2SC2001
Q510	8-729-195-23	TRANSISTOR 2SA952
Q511	8-729-195-23	TRANSISTOR 2SA952
Q512	8-729-100-13	TRANSISTOR 2SC2001
Q513	8-729-663-47	TRANSISTOR 2SC1364
Q514	8-729-180-93	TRANSISTOR 2SD809
Q601	8-729-663-47	TRANSISTOR 2SC1364
Q602	8-729-663-47	TRANSISTOR 2SC1364
Q603	8-729-663-47	TRANSISTOR 2SC1364
Q604	8-729-602-68	TRANSISTOR 2SA1026
Q701	8-729-612-77	TRANSISTOR 2SA1027R
Q702	8-729-612-77	TRANSISTOR 2SA1027R
Q703	8-729-612-77	TRANSISTOR 2SA1027R
Q704	8-729-612-77	TRANSISTOR 2SA1027R
Q705	8-729-612-77	TRANSISTOR 2SA1027R
Q706	8-729-612-77	TRANSISTOR 2SA1027R
Q707	8-729-612-77	TRANSISTOR 2SA1027R
Q708	8-729-612-77	TRANSISTOR 2SA1027R
Q709	8-729-612-77	TRANSISTOR 2SA1027R
Q710	8-729-612-77	TRANSISTOR 2SA1027R
Q711	8-729-612-77	TRANSISTOR 2SA1027R
Q712	8-729-612-77	TRANSISTOR 2SA1027R
Q713	8-729-612-77	TRANSISTOR 2SA1027R
Q714	8-729-612-77	TRANSISTOR 2SA1027R
Q715	8-729-612-77	TRANSISTOR 2SA1027R
Q716	8-729-612-77	TRANSISTOR 2SA1027R
Q717	8-729-612-77	TRANSISTOR 2SA1027R
Q718	8-729-612-77	TRANSISTOR 2SA1027R
Q719	8-729-612-77	TRANSISTOR 2SA1027R
Q720	8-729-612-77	TRANSISTOR 2SA1027R
Q721	8-729-612-77	TRANSISTOR 2SA1027R
Q722	8-729-612-77	TRANSISTOR 2SA1027R
Q803	8-729-110-21	TRANSISTOR PH102
Q804	8-729-110-21	TRANSISTOR PH102
Q901	8-729-288-02	TRANSISTOR 2SD880
Q902	8-729-663-47	TRANSISTOR 2SC1364
Q903	8-729-663-47	TRANSISTOR 2SC1364
Q904	8-729-288-02	TRANSISTOR 2SD880
Q905	8-729-663-47	TRANSISTOR 2SC1364
Q906	8-729-288-02	TRANSISTOR 2SD880
Q907	8-729-663-47	TRANSISTOR 2SC1364

NOTE:

- Items with no part number and no description are not stocked because they are seldom required for routine service.
- Items marked " * " are not stocked since they are seldom required for routine service. Some delay should be anticipated when ordering these items.
- Due to standardization, parts with part numbers (Δ-ΔΔΔ-ΔΔΔ-XX or Δ-ΔΔΔΔ-ΔΔΔ-X) may be different from those used in the set.

CAPACITORS:

- All capacitors are in μF. Common capacitors are omitted. Refer to the following lists for their part numbers. MF:μF, PF:μμF.

RESISTORS

- All resistors are in ohms. Common 1/4W, 1/8W and 1/16W carbon resistors are omitted. Refer to the following lists for their part numbers.

- F : nonflammable

COILS

- MMH : mH, UH : μH

The components identified by shading and mark are critical for safety. Replace only with part number specified.

Les composants identifiés par une trame et une marque sont critiques pour la sécurité. Ne les remplacer que par une pièce portant le numéro spécifié.

SEMICONDUCTORS

- In each case, U : μ, for example: UA...: μA..., UPA...: μPA..., UPC...: μPC, UPD...: μPD...

ELECTRICAL PARTS

Ref.No.	Part No.	Description				
R006	1-214-865-00	METAL	1.1K	1%	1/2W	
R007	1-214-865-00	METAL	1.1K	1%	1/2W	
R037	▲.1-212-857-00	FUSIBLE	10	5%	1/4W	F
R038	▲.1-212-857-00	FUSIBLE	10	5%	1/4W	F
R505	▲.1-206-477-00	METAL	39	5%	2W	F
R508	▲.1-206-482-00	METAL	62	5%	2W	F
R532	▲.1-212-849-00	FUSIBLE	4.7	5%	1/4W	F
R901	▲.1-217-395-00	FUSIBLE	47	5%	1/4W	F
R903	▲.1-244-863-00	CARBON	390	5%	1/2W	
R907	▲.1-213-063-00	FUSIBLE	13	5%	1W	F
R908	▲.1-244-853-00	CARBON	150	5%	1/2W	
R909	▲.1-212-966-00	FUSIBLE	22	5%	1/2W	F
RV101	1-226-991-00	RES, VAR, SLIDE	20K/20K			
RV102	1-228-505-00	RES, ADJ, METAL GLAZE	10K			
RV103	1-226-236-00	RES, ADJ, CARBON	10K			
RV104	1-226-140-00	RES, VAR	20K/20K			
RV201	1-226-991-00	RES, VAR, SLIDE	20K/20K			
RV202	1-228-505-00	RES, ADJ, METAL GLAZE	10K			
RV203	1-226-236-00	RES, ADJ, CARBON	10K			
RV204	1-226-140-00	RES, VAR	20K/20K			
RV301	1-228-221-00	RES, ADJ, METAL GLAZE	20K			
RV401	1-228-221-00	RES, ADJ, METAL GLAZE	20K			
RY001	1-515-323-00	RELAY				
S1	1-553-993-00	SWITCH, PUSH (4 KEY)	(TAPE 1)			
S005	1-553-992-00	SWITCH, PUSH (3 KEY)	(DOLBY B)			
S508	1-553-206-00	SWITCH, SLIDE, TIMER				
S801	1-552-532-00	SWITCH, PUSH				
S802	1-552-532-00	SWITCH, PUSH				
S901	▲.1-553-319-00	(US,Canadian)...SWITCH, PUSH	(POWER)			
S901	▲.1-553-318-00	(AEP,UK).....SWITCH, PUSH	(POWER)			
T901	▲.1-447-273-00	(US,Canadian)...TRANSFORMER, POWER				
T901	▲.1-447-275-00	(AEP,UK).....TRANSFORMER, POWER				
X501	1-527-802-00	OSCILLATOR, CERAMIC				

For Service Manuals Contact
MAURITRON TECHNICAL SERVICES
 8 Cherry Tree Rd, Chinnor
 Oxon OX9 4QY
 Tel: 01844-351694 Fax: 01844-352554
 Email: enquiries@mauriton.co.uk

NOTE:
 · Items with no part number and no description are not stocked because they are seldom required for routine service.
 · Items marked "▲" are not stocked since they are seldom required for routine service. Some delay should be anticipated when ordering these items.
 · Due to standardization, parts with part numbers (▲-▲▲▲-▲▲▲-XX or ▲-▲▲▲-▲▲▲-X) may be different from those used in the set.

CAPACITORS:
 · All capacitors are in μ F. Common capacitors are omitted. Refer to the following lists for their part numbers.
 MF: μ F, PF: μ F.
 RESISTORS
 · All resistors are in ohms. Common 1/4W, 1/8W and 1/16W carbon resistors are omitted. Refer to the following lists for their part numbers.
 · F : nonflammable
 COILS
 · MMH : mH, UH : μ H

The components identified by shading and mark ▲ are critical for safety. Replace only with part number specified.

Les composants identifiés par une trame et une marque ▲ sont critiques pour la sécurité. Ne les remplacer que par une pièce portant le numéro spécifié.

SEMICONDUCTORS
 In each case, U : μ , for example:
 UA... : μ A..., UPA... : μ PA..., UPC... : μ PC,
 UPD... : μ PD...

ELECTROLYTIC CAPACITORS

CAP. (μF)	RATING → : Use the high voltage rated one.					
	6.3 VOLT.	10 VOLT.	16 VOLT.	25 VOLT.	35 VOLT.	50 VOLT.
	PART No.	PART No.	PART No.	PART No.	PART No.	PART No.
0.47						1-121-726-00
1.0						1-121-391-00
2.2						1-121-450-00
3.3	→	→	→	1-121-392-00	→	1-121-393-00
4.7	→	→	→	1-121-395-00	→	1-121-396-00
10	→	→	1-121-651-00	1-121-398-00	→	1-121-738-00
22	→	→	1-121-479-00	1-121-480-00	1-121-662-00	1-121-152-00
33	→	→	1-121-403-00	1-121-404-00	1-121-652-00	1-121-405-00
47	→	1-121-352-00	1-121-409-00	1-121-410-00	1-121-653-00	1-121-411-00
100	→	1-121-414-00	1-121-415-00	1-121-416-00	1-121-357-00	1-121-417-00
220	1-121-419-00	1-121-420-00	1-121-421-00	1-121-422-00	1-121-261-00	1-121-423-00
330	1-121-751-00	1-121-805-00	1-121-521-00	1-121-654-00	1-121-655-00	1-121-656-00
470	1-121-424-00	1-121-425-00	1-121-426-00	1-121-733-00	1-121-361-00	1-121-810-00
1000	-	1-121-736-00	1-121-245-00	1-121-657-00	1-121-388-00	1-123-061-00
2200	1-121-658-00	1-121-659-00	1-121-660-00	1-123-067-00	1-121-984-00	-
3300	1-121-661-00	1-123-075-00	1-123-071-00	-	-	-

CAP. (μF)	100 VOLT.	160 VOLT.	250 VOLT.	350 VOLT.
	PART No.	PART No.	PART No.	PART No.
0.47	-	-	-	-
1.0	1-123-249-00	1-123-252-00	1-123-003-00	1-121-168-00
2.2	1-123-250-00	1-123-026-00	-	1-123-028-00
3.3	1-121-995-00	-	1-123-004-00	1-123-006-00
4.7	1-123-255-00	1-121-246-00	1-121-759-00	1-123-007-00
10	1-121-126-00	1-121-999-00	1-123-254-00	1-123-008-00
22	1-121-996-00	1-123-253-00	1-123-005-00	1-123-022-00
33	1-121-997-00	1-121-757-00	-	-
47	1-123-251-00	1-121-919-00	-	-
100	1-123-084-00	-	-	-

CERAMIC CAPACITORS

CAP. (pF)	RATING						
	50 VOLT.	CAP. (pF)	50 VOLT.	CAP. (pF)	50 VOLT.	CAP. (μF)	50 VOLT.
	PART No.		PART No.		PART No.		PART No.
0.5	1-101-837-00	22	1-102-959-00	150	1-101-361-00	0.001	1-102-074-00
0.75	1-101-586-00	24	1-102-960-00	160	1-101-367-00	0.0012	1-102-118-00
1.0	1-102-934-00	27	1-102-961-00	180	1-102-976-00	0.0015	1-102-119-00
1.5	1-101-576-00	30	1-102-962-00	200	1-102-977-00	0.0018	1-102-120-00
2.0	1-102-935-00	33	1-102-963-00	220	1-102-978-00	0.0022	1-102-121-00
3	1-102-936-00	36	1-102-964-00	240	1-102-979-00	0.0027	1-102-122-00
4	1-102-937-00	39	1-102-965-00	270	1-102-980-00	0.0033	1-102-123-00
5	1-102-942-00	43	1-102-966-00	300	1-102-981-00	0.0039	1-102-124-00
6	1-102-943-00	47	1-101-880-00	330	1-102-820-00	0.0047	1-102-125-00
7	1-102-944-00	51	1-101-882-00	360	1-102-821-00	0.0056	1-102-126-00
8	1-102-945-00	56	1-101-884-00	390	1-102-822-00	0.0068	1-102-127-00
9	1-102-946-00	62	1-101-886-00	430	1-102-823-00	0.0082	1-102-128-00
10	1-102-947-00	68	1-101-888-00	470	1-102-824-00	0.01	1-102-129-00
11	1-102-948-00	75	1-101-890-00	510	1-101-059-00	0.022	1-101-005-00
12	1-102-949-00	82	1-102-971-00	560	1-102-115-00	0.047	1-101-006-00
13	1-102-950-00	91	1-102-972-00	680	1-102-116-00		
15	1-102-951-00	100	1-102-973-00	820	1-102-117-00		
16	1-102-952-00	110	1-102-815-00				
18	1-102-953-00	120	1-102-816-00				
20	1-102-958-00	130	1-101-081-00				

0.001μF = 1,000pF

CERAMIC (SEMICONDUCTOR) CAPACITORS

CAP. (μF)	RATING → : Use the high voltage rated one.				
	25 VOLT.	50 VOLT.	CAP. (μF)	25 VOLT.	50 VOLT.
	PART No.	PART No.		PART No.	PART No.
0.001	→	1-161-039-00	0.018	1-161-016-00	1-161-054-00
0.0012	→	1-161-040-00	0.022	1-161-017-00	1-161-055-00
0.0015		1-161-041-00	0.027	1-161-018-00	1-161-056-00
0.0018		1-161-042-00	0.033	1-161-019-00	1-161-057-00
0.0022		1-161-043-00	0.039	1-161-010-00	1-161-058-00
0.0027	→	1-161-044-00	0.047	1-161-021-00	1-161-059-00
0.0033	→	1-161-045-00	0.056	→	1-161-060-00
0.0039	→	1-161-046-00	0.068	→	1-161-061-00
0.0047	→	1-161-047-00	0.082	1-161-024-00	1-161-062-00
0.0056	→	1-161-048-00	0.1	1-161-025-00	1-161-063-00
0.0068	→	1-161-049-00			
0.0082	1-161-012-00	1-161-050-00			
0.01	1-161-013-00	1-161-051-00			
0.012	→	1-161-052-00			
0.015	1-161-015-00	1-161-053-00			

MYLAR CAPACITORS

CAP. (μF)	RATING																		
	50 VOLT.			100 VOLT.			200 VOLT.			CAP. (μF)	50 VOLT.			100 VOLT.			200 VOLT.		
	PART No.	PART No.	PART No.	PART No.	PART No.	PART No.	PART No.	PART No.	PART No.		PART No.	PART No.	PART No.	PART No.	PART No.	PART No.	PART No.	PART No.	
0.001	1-108-227-00	1-108-365-00	1-108-409-00	0.01	1-108-239-00	1-108-377-00	1-108-421-00	0.1	1-108-251-00	1-108-389-00	1-108-433-00								
0.0012	1-108-351-00	1-108-366-00	1-108-410-00	0.012	1-108-357-00	1-108-378-00	1-108-422-00	0.12	1-108-363-00	1-108-390-00	1-108-434-00								
0.0015	1-108-228-00	1-108-367-00	1-108-411-00	0.015	1-108-240-00	1-108-379-00	1-108-423-00	0.15	1-108-252-00	1-108-391-00	1-108-435-00								
0.0018	1-108-352-00	1-108-368-00	1-108-412-00	0.018	1-108-358-00	1-108-380-00	1-108-424-00	0.18	1-108-364-00	1-108-392-00	1-108-436-00								
0.0022	1-108-230-00	1-108-369-00	1-108-413-00	0.022	1-108-242-00	1-108-381-00	1-108-425-00	0.22	1-108-254-00	1-108-393-00	1-108-437-00								
0.0027	1-108-353-00	1-108-370-00	1-108-414-00	0.027	1-108-359-00	1-108-382-00	1-108-426-00	0.27	1-108-854-00	-	-								
0.0033	1-108-232-00	1-108-371-00	1-108-415-00	0.033	1-108-244-00	1-108-383-00	1-108-427-00	0.33	1-108-855-00	-	-								
0.0039	1-108-354-00	1-108-372-00	1-108-416-00	0.039	1-108-360-00	1-108-384-00	1-108-428-00	0.39	1-108-856-00	-	-								
0.0047	1-108-234-00	1-108-373-00	1-108-417-00	0.047	1-108-246-00	1-108-385-00	1-108-429-00	0.47	1-108-857-00	-	-								
0.0056	1-108-355-00	1-108-374-00	1-108-418-00	0.056	1-108-361-00	1-108-386-00	1-108-430-00	-	-	-	-								
0.0068	1-108-237-00	1-108-375-00	1-108-419-00	0.068	1-108-249-00	1-108-387-00	1-108-431-00	-	-	-	-								
0.0082	1-108-356-00	1-108-376-00	1-108-420-00	0.082	1-108-362-00	1-108-388-00	1-108-432-00	-	-	-	-								

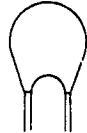

TANTALUM CAPACITORS

For Service Manuals Contact
MAURITRON TECHNICAL SERVICES
 8 Cherry Tree Rd, Chinnor
 Oxon OX9 4QY
 Tel:- 01844-351694 Fax:- 01844-352554
 Email:- enquiries@mauritron.co.uk

CAP. (μF)	RATING → Use the high voltage rated one.						
	3.15 VOLT.	6.3 VOLT.	10 VOLT.	16 VOLT.	20 VOLT.	25 VOLT.	35 VOLT.
	PART No.	PART No.	PART No.	PART No.	PART No.	PART No.	PART No.
0.01							
0.015					→	→	1-131-396-00
0.022					→	→	1-131-397-00
0.033					→	→	1-131-398-00
0.047					→	→	1-131-399-00
0.068					→	→	1-131-400-00
0.1					→	→	1-131-401-00
0.15					→	→	1-131-402-00
0.22					→	→	1-131-403-00
0.33					→	→	1-131-404-00
0.47	-	-	-	-	→	→	1-131-405-00
0.68	-	-	-	-	1-131-412-00	→	1-131-406-00
1.0	-	-	-	1-131-415-00	→	1-131-410-00	1-131-407-00
1.5	-	1-131-421-00	1-131-418-00	1-131-416-00	1-131-413-00	→	1-131-408-00
2.2	1-131-424-00	-	1-131-419-00	-	→	1-131-411-00	1-131-348-00
3.3	-	-	-	-	1-131-414-00	1-131-355-00	1-131-349-00
4.7	1-131-425-00	1-131-422-00	1-131-420-00	1-131-417-00	1-131-362-00	1-131-356-00	1-131-350-00
6.8	-	-	1-131-376-00	1-131-369-00	1-131-363-00	1-131-357-00	1-131-351-00
10	1-131-426-00	1-131-423-00	1-131-377-00	1-131-370-00	1-131-364-00	1-131-358-00	1-131-352-00
15	1-131-390-00	1-131-383-00	1-131-378-00	1-131-371-00	1-131-365-00	1-131-359-00	1-131-353-00
22	1-131-391-00	1-131-384-00	1-131-379-00	1-131-372-00	1-131-366-00	1-131-360-00	-
33	1-131-392-00	1-131-385-00	1-131-380-00	1-131-373-00	1-131-367-00	-	-
47	1-131-393-00	1-131-386-00	1-131-381-00	1-131-374-00	-	-	-
68	1-131-394-00	1-131-387-00	-	-	-	-	-
100	1-131-395-00	1-131-388-00	-	-	-	-	-



TANTALUM CAPACITORS

CAP. (μF)	RATING					
	3 VOLT.	6.3 VOLT.	10 VOLT.	16 VOLT.	20 VOLT.	35 VOLT.
	PART No.	PART No.	PART No.	PART No.	PART No.	PART No.
0.033						1-131-273-00
0.047						1-131-274-00
0.068						1-131-275-00
0.1						1-131-276-00
0.15						1-131-277-00
0.22						-
0.33					1-131-262-00	1-131-278-00
0.47					1-131-263-00	1-131-279-00
0.68			1-131-169-00		1-131-264-00	1-131-280-00
1.0					1-131-258-00	1-131-281-00
1.5			1-131-254-00		1-131-265-00	1-131-282-00
2.2		1-131-250-00			1-131-266-00	-
3.3					1-131-267-00	1-131-283-00
4.7			1-131-255-00	1-131-259-00	1-131-268-00	1-131-284-00
6.8		1-131-251-00	1-131-171-00		1-131-269-00	-
10				1-131-260-00	1-131-270-00	-
15					1-131-271-00	-
22		1-131-252-00		1-131-261-00	1-131-272-00	-
33	1-131-176-00		1-131-257-00		-	-
47	1-131-288-00	1-131-253-00	1-131-173-00		-	-
100	1-131-177-00	1-131-174-00			-	-

1/4 WATT CARBON RESISTORS

Ω	Part No.	Ω	Part No.	Ω	Part No.	Ω	Part No.	Ω	Part No.	Ω	Part No.	Ω	Part No.
1.0	1-246-401-00	10	1-246-425-00	100	1-246-449-00	1.0k	1-246-473-00	10k	1-246-497-00	100k	1-246-521-00	1.0M	1-246-545-00
1.1	1-246-402-00	11	1-246-426-00	110	1-246-450-00	1.1k	1-246-474-00	11k	1-246-498-00	110k	1-246-522-00	1.1M	1-210-814-00
1.2	1-246-403-00	12	1-246-427-00	120	1-246-451-00	1.2k	1-246-475-00	12k	1-246-499-00	120k	1-246-523-00	1.2M	1-210-815-00
1.3	1-246-404-00	13	1-246-428-00	130	1-246-452-00	1.3k	1-246-476-00	13k	1-246-500-00	130k	1-246-524-00	1.3M	1-210-816-00
1.5	1-246-405-00	15	1-246-429-00	150	1-246-453-00	1.5k	1-246-477-00	15k	1-246-501-00	150k	1-246-525-00	1.5M	1-210-817-00
1.6	1-246-406-00	16	1-246-430-00	160	1-246-454-00	1.6k	1-246-478-00	16k	1-246-502-00	160k	1-246-526-00	1.6M	1-210-818-00
1.8	1-246-407-00	18	1-246-431-00	180	1-246-455-00	1.8k	1-246-479-00	18k	1-246-503-00	180k	1-246-527-00	1.8M	1-210-819-00
2.0	1-246-408-00	20	1-246-432-00	200	1-246-456-00	2.0k	1-246-480-00	20k	1-246-504-00	200k	1-246-528-00	2.0M	1-210-820-00
2.2	1-246-409-00	22	1-246-433-00	220	1-246-457-00	2.2k	1-246-481-00	22k	1-246-505-00	220k	1-246-529-00	2.2M	1-210-821-00
2.4	1-246-410-00	24	1-246-434-00	240	1-246-458-00	2.4k	1-246-482-00	24k	1-246-506-00	240k	1-246-530-00	2.4M	1-244-754-00
2.7	1-246-411-00	27	1-246-435-00	270	1-246-459-00	2.7k	1-246-483-00	27k	1-246-507-00	270k	1-246-531-00	2.7M	1-244-755-00
3.0	1-246-412-00	30	1-246-436-00	300	1-246-460-00	3.0k	1-246-484-00	30k	1-246-508-00	300k	1-246-532-00	3.0M	1-244-756-00
3.3	1-246-413-00	33	1-246-437-00	330	1-246-461-00	3.3k	1-246-485-00	33k	1-246-509-00	330k	1-246-533-00	3.3M	1-244-757-00
3.6	1-246-414-00	36	1-246-438-00	360	1-246-462-00	3.6k	1-246-486-00	36k	1-246-510-00	360k	1-246-534-00	3.6M	1-244-758-00
3.9	1-246-415-00	39	1-246-439-00	390	1-246-463-00	3.9k	1-246-487-00	39k	1-246-511-00	390k	1-246-535-00	3.9M	1-244-759-00
4.3	1-246-416-00	43	1-246-440-00	430	1-246-464-00	4.3k	1-246-488-00	43k	1-246-512-00	430k	1-246-536-00	4.3M	1-244-760-00
4.7	1-246-417-00	47	1-246-441-00	470	1-246-465-00	4.7k	1-246-489-00	47k	1-246-513-00	470k	1-246-537-00	4.7M	1-244-761-00
5.1	1-246-418-00	51	1-246-442-00	510	1-246-466-00	5.1k	1-246-490-00	51k	1-246-514-00	510k	1-246-538-00	5.1M	1-244-762-00
5.6	1-246-419-00	56	1-246-443-00	560	1-246-467-00	5.6k	1-246-491-00	56k	1-246-515-00	560k	1-246-539-00		
6.2	1-246-420-00	62	1-246-444-00	620	1-246-468-00	6.2k	1-246-492-00	62k	1-246-516-00	620k	1-246-540-00		
6.8	1-246-421-00	68	1-246-445-00	680	1-246-469-00	6.8k	1-246-493-00	68k	1-246-517-00	680k	1-246-541-00		
7.5	1-246-422-00	75	1-246-446-00	750	1-246-470-00	7.5k	1-246-494-00	75k	1-246-518-00	750k	1-246-542-00		
8.2	1-246-423-00	82	1-246-447-00	820	1-246-471-00	8.2k	1-246-495-00	82k	1-246-519-00	820k	1-246-543-00		
9.1	1-246-424-00	91	1-246-448-00	910	1-246-472-00	9.1k	1-246-496-00	91k	1-246-520-00	910k	1-246-544-00		

HARDWARE NOMENCLATURE

Screw:

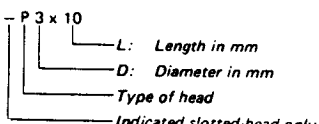

Unless otherwise indicated, it means cross-recessed head (Phillips type).

Nut, Washer, Retaining ring:

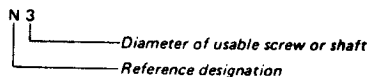

Reference Designation	Shape	Description	Remarks
SCREWS			
P		pan-head screw	binding-head (B) screw for replacement
PWH		pan-head screw with washer face	binding-head (B) screw and flat washer for replacement
PS PSP		pan-head screw with spring washer	binding-head (B) screw and spring washer for replacement
PSW PSPW		pan-head screw with spring and flat washers	binding-head (B) screw and spring and flat washers for replacement
R		round-head screw	binding-head (B) screw for replacement
K		flat-countersunk-head screw	
RK		oval-countersunk-head screw	
B		binding-head screw	
T		truss-head screw	binding-head (B) screw for replacement
F		flat-fillister-head screw	
RF		fillister-head screw	
BV		brazier-head screw	

Reference Designation	Shape	Description	Remarks
SELF-TAPPING SCREWS			
TA		self-tapping screw	ex: TA, P 3 x 10
PTP		pan-head self-tapping screw	binding-head self-tapping (TA, B) screw for replacement
PTPWH		pan-head self-tapping screw with washer face	binding-head self-tapping (TA, B) screw and flat washer for replacement
PTTWH		pan-head thread-rolling screw with washer face	binding-head (B) screw and flat washer for replacement
SET SCREWS			
SC		set screw	
SC		hexagon-socket set screw	ex: SC 2.6 x 4, hexagon socket
NUT			
N		nut	
WASHERS			
W		flat washer	
SW		spring washer	
LW		internal-tooth lock washer	ex: LW3, internal
LW		external-tooth lock washer	ex: LW3, external
RETAINING RINGS			
E		retaining ring	
G		grip-type retaining ring	